

## GT6 General Purpose Ignition System.

## User Manual



## Index

		Page
1	Introduction	2
2	Features	2
3	Installation	3
3.1	General Information	3
3.1.1	Igniter Installation and Location	3
3.1.2	Ignition Coil Location	3
3.1.3	Wiring Harness	4
3.1.4	HT Lead Recommendations	4
3.1.5	Timing Disc and Engine Position Sensor Installation	4
3.1.5.1	Installing the Gill supplied Timing Disc	4
3.1.5.2	Dual Timing Disc Installation	5
3.1.5.3	Inductive Engine Position Sensors	5
3.1.5.4	Hall Effect Engine Position Sensors	5
3.1.6	Igniter LED Display	5
3.2	GillFire Software	6
3.2.1	Communications Software	6
3.2.2	Installing the GillFire Software	6
3.2.3	Running the GillFire Software	6
3.2.4	GillFire Program Configuration Facility	7
3.2.5	GillFire Main Screen	8
3.2.6	The GillFire Monitor Screen	9
3.2.7	The GillFire Diagnostics Screen	11
3.2.8	The GillFire Ignition Spark Timing Screen	12
3.2.9	The GillFire Ignition Mapping Screen	13
3.2.10	The GillFire Ignition Mapping Graph Screen	16
3.2.11	The GillFire Dwell Setup Screen	17
3.2.12	The GillFire Ignition Suppression Screen	18
3.2.14	The GillFire Digital Output Screen	19
4	Wiring Diagram (Igniter Connector Pin-out Arrangement)	20
Appendix 1	GT6 Option 1 Wiring Diagram	21
Appendix 2	GT6 Option 2 Wiring Diagram	22
Appendix 3	GT6 Option 3 Wiring Diagram	23
Appendix 4	Timing Disc and Pickup Arrangement	24
Appendix 5	GT6 Dimensioned Drawing	25

## 1. INTRODUCTION

The Gill GT6 Ignition Systems is primarily targeted at gaseous fuelled (CNG, Natural Gas, etc) engines (wasted and non-wasted spark) with up to 6 cylinders, static and non mobile, vehicles, gensets, compressors etc.

The GS6 System consists of the following components:

- Igniter module;
- Wiring harness;
- Ignition coils;
- Engine Position Sensor;
- Timing Disc; (this can be supplied by Gill Instruments Ltd or used with existing OEM disc)
- Programming Software;
- and this Operating Manual.

## 2. Features

- 1, 2,3,4,5 and 6 cylinder operation with one coil per cylinder
- Programmable ignition control maps.
- Digital input or analogue input (e.g. over temperature).
- Programmable ignition and fuel cut off rpm limits.
- Progressive rpm limiting.
- Programmable global timing retard for dual fuel operation.
- Programmable Timing correction for EPS positioning errors.
- Programmable nominal dwell times.
- Dwell period versus Battery voltage compensation.
- Operates with TPS or MAP sensor.
- Built-in diagnostic LED lamp.
- Configurable Speed Output signal.
- Operates with universal timing disc geometry.
- Operates with crank / cam sensor configurations.
- Can be configured for alternative Timing Discs and Engine Position Sensors.
- Controlled access Gill-Fire software.
- Operates with Gill Coils or can be configured for OEM ignition coils.

### 3. INSTALLATION

Prior to installing the GT6 system, please ensure that all relevant components have been supplied, especially that the correct number of ignition coils and the correct timing disc or configuration for OEM disc is present.

#### 3.1 General Information

The GT6 can be configured for 1, 2, 3, 4, 5 and 6 cylinder engines. The GT6 is available in three formats depending on your pickup configurations:

Option 1 = 1 Inductive pickup and 1 Hall pickup (inductive primary pickup)

- Gill Part Number: 1521-00-011

Option 2 = Either 1 or 2 Inductive pickups

- Gill Part Number: 1521-00-012

Option 3 = Either 1 or 2 Hall pickups

- Gill Part Number: 1521-00-013

**Please Note:**

The coils are numbered in Igniter firing order, NOT the engine firing order. Ensure that the coil HT leads are wired to the correct cylinders in the correct firing order.

##### 3.1.1 Igniter Installation and location

It is strongly advised to mount the Igniter away from sources of heat and excessive vibration for optimum reliability.

If installed in the engine compartment, mount the igniter low down and away from exhaust pipes and hot air from radiators.

If the Igniter is to be installed remote from the engine, and therefore the ignition coils, ensure the wiring harness is of sufficient length – please contact Gill if an extended wiring harness is required.

Note: the Igniter is designed for **NEGATIVE EARTH** battery operation only.

Gill recommends a torque setting of 11.0Nm (8.0 lbf.ft) for the fixing bolts.

##### 3.1.2 Ignition Coil location

Ensure that the coils are securely mounted and that the mounting flanges are not stressed. Keep the coils away from direct contact with the engine cylinder head or exhaust manifold, preferably using rubber mountings for resistance to any vibration-induced damage.

The coils should be installed as close as practicable to the engine to avoid long HT cable length.

Gill recommends a torque setting of 8.0Nm (5.5 lbf.ft) for the coil fixing bolts and a maximum of 2Nm (1.5 lbf.ft) for the brass low-tension terminal nuts on terminal type coils.

When installing a Terminal type coil, always use a 5mm ring termination for wiring to the terminals and fit the supplied spring washers.

**Note: It is most important that the coil low-tension connection polarity is correct or premature coil failure could result.**

**Coils will withstand only short periods of operation with reversed LT connections.**

**Gill advises that this warning be included in your engine service literature.**

**The centre low-tension terminal on SM100 coils MUST be securely connected to an engine ground or premature coil failure will occur.**

### 3.1.3 Wiring Harness

Ensure that the wiring is correctly fitted into the Igniter connector header (see the Wiring Diagram in Appendix 1 for details).  
Also ensure that the wiring loom is suitably clipped along its length for security.  
Avoid installing the wiring loom too close to the Ignition coils to ensure freedom from any possible electrical interference effects.

### 3.1.4 HT Lead recommendations

Gill recommends the use of spark plugs with a built in interference suppressor and carbon core HT leads with suitable coil and spark plug caps. It is preferable to maintain the same length of HT lead to each spark plug with this type of lead as their resistance varies with length.

Do not exceed a total nominal resistance of 20kohm (plug plus cap plus lead).  
It is the responsibility of the user to choose the correct types of spark plugs, caps and HT leads in order to meet EMC (interference) emission regulations.

### 3.1.5 Timing Disc and Engine Position Sensor installation

The correct installation of the Timing Disc(s) and Engine Position Sensor(s) (EPS) is critical for reliable operation of the Gill GT6 Ignition System.  
GT6 can be configured to run from most combinations of OEM/Customer specific timing discs or standard Gill supplied discs can be used.

Please contact Gill for advice on disc parameters.  
Refer to Appendix 4 for the standard Gill Timing Disc and Engine Position Sensor Drawing.

#### 3.1.5.1 Installing the Gill Supplied Timing Disc

The standard configuration for the GT6 timing disc is for it to be fitted to the camshaft or other half crankshaft speed shaft.  
The disc should normally rotate anti-clockwise in the direction of the arrow; for clockwise rotation reverse the disc so the arrow is on the inner face.

To time the system, set the engine to TDC on cylinder 1 (firing) then align the scribed TDC line on the disc with the centre of the Engine Position Sensor "pin".

The clearance between the EPS and timing disc (for the standard Gill 90mm (3½") disc) should be set as follows:

For the Standard Gill Inductive Pickup: - 1.5mm to 2.0mm, ideally 2.0 mm (0.080").

For the Gill Threaded Inductive pickup: - 0.5mm to 1.00mm, ideally 0.75mm (0.030").

For the Gill Push-in Inductive pickup: - 0.5mm to 1.00mm, ideally 0.75mm (0.030").

It is essential that both radial and sideways run out of the disc is less than 0.2mm each way and the total of sideways run out and end float must not exceed 0.5mm with the Engine Position Sensor mounted centrally to the timing disc as shown in drawing 1470 -K -014 (Appendix 4).

The timing disc is supplied as standard with a centre-mounting hole of 10mm diameter.

The disc should be securely fitted to the mounting shaft, if necessary using additional means of ensuring it cannot move, e.g. keyway or dowelling accordingly.

Gill recommends a torque setting of 11.0Nm (8.0 lbf.ft.) for the fixing bolts.

Contact Gill for advice on non-standard disc designs.

### 3.1.5.2 Dual Timing Disc Installation

Where an installation uses a crankshaft mounted (Primary) timing disc in conjunction with a camshaft mounted (Secondary) timing disc, the installation requirements are as above.

### 3.1.5.3 Inductive Engine Position Sensors

The standard Gill Engine Position Sensor (EPS) is a conventional inductive unit. It is polarity sensitive; if connected in reverse the engine may not run at all, or if it does, it will experience substantial timing errors and is likely to misfire. Refer to the drawing 1470-K-014 (Appendix 4) for the correct alignment with the timing disc and the disc "pegs".

It is important to mount the EPS rigidly so that it cannot be affected by vibration, to ensure reliable performance of the Ignition system

The wires from the EPS must be run close together, but should not be run with other wiring over large distances. Screened twisted pair wiring is recommended for lengths over 2 metres.

Gill does not recommend sensor cable lengths over 5 metres.

### 3.1.5.4 Hall effect Engine Position Sensors

Where the Engine Position Sensor is of the Hall-effect type the sensor manufacturer's specifications for sensor mounting, disc clearance and alignment must be adhered to.

The wiring arrangement for Hall effect sensors is shown in Appendix 2.

Contact Gill for advice on alternative Engine Position Sensors.

### 3.1.6 Igniter Led Display

One on-board status indicator is provided;

The LED display located on the Igniter next to the 18 way connector shows the following information:

#### **Flashing On 0.2 Seconds Off 0.8 Seconds**

This indicates that there is power to the Igniter.

#### **Flashing On 0.25 Seconds Off 0.25 Seconds**

This indicates that the igniter has corrupted or has not been loaded with a correct configuration file.

#### **Permanently On**

The LED will remain lit when the Igniter has successfully synchronised to the timing disc.

## 3.2 GillFire SOFTWARE INSTALLATION

This topic covers programming requirements and steps involved to install and run the GillFire Graphical User Interface (GUI) software.

### 3.2.1 Communications Software

The system is supplied with a Windows® based **GillFire** software CD.

According to the specification required, **GillFire** can enable the user to adjust the timing curve and other programmable information within the igniter and also to download operational information from the igniter.

A 9 way D type connector is fitted in the wiring loom. This should be connected to the COM 1 or COM 2 port of the user's PC (via a standard comms cable – not supplied).

### 3.2.3 INSTALLING THE GILLFIRE SOFTWARE

1. Follow normal Windows® procedure to remove any existing GillFire software - (Start – Settings – Control Panel – Add / Remove programs).
2. Load the GillFire Installation CD into the PC.
3. Click on Start – Run – Browse – locate the “GillFire” CD icon and click on it.
4. Click on the Setup icon that appears in the window. Click on Open, and then click on OK.
5. Follow the Wizard Instructions.

#### **NOW INSTALL THE ‘GILLFIRE’ CONFIGURATION’ DISC**

After installing the GillFire software, the GillFire “GUI CONFIGURATION” disc should be installed if necessary.

### 3.2.4 Running the GillFire program

Click on Start – Programs – GillFire, and click on the GillFire tab to run the program.

Alternatively, “Drag and Drop” the GillFire tab to create a desktop icon ‘shortcut’ on your PC as required.

Then double click on this GillFire GUI icon ‘shortcut’ to run the program.

Note: It is not necessary to connect the igniter to be able to run the GillFire GUI software program. This is to enable users to familiarise themselves with the operation and programming procedures before installing and programming the system.

We also recommend you read the GillFire GUI Help Directory to familiarise yourself with the GillFire GUI software and the Igniter's features and functionality.

### 3.2.5 GillFire access files

The GillFire program can be modified for the available Igniter programmability to suit the requirements of the Engine / Installation Manufacturer ("The Customer")

This means that the Manufacturer can have all the programming features relevant to their requirements whereas their Field Engineers or End Users can be limited to a "Read Only" capability, for example.

This ensures that the Ignition system's parameters can only be altered or modified by the Engine / Installation Manufacturer or their Authorised Agents.

The GillFire program will then operate according to the access file supplied.

Contact Gill for further information on Configuration facility.

**If no access file is installed, then the GillFire is a read only program**



### 3.2.6 GillFire Main Screen

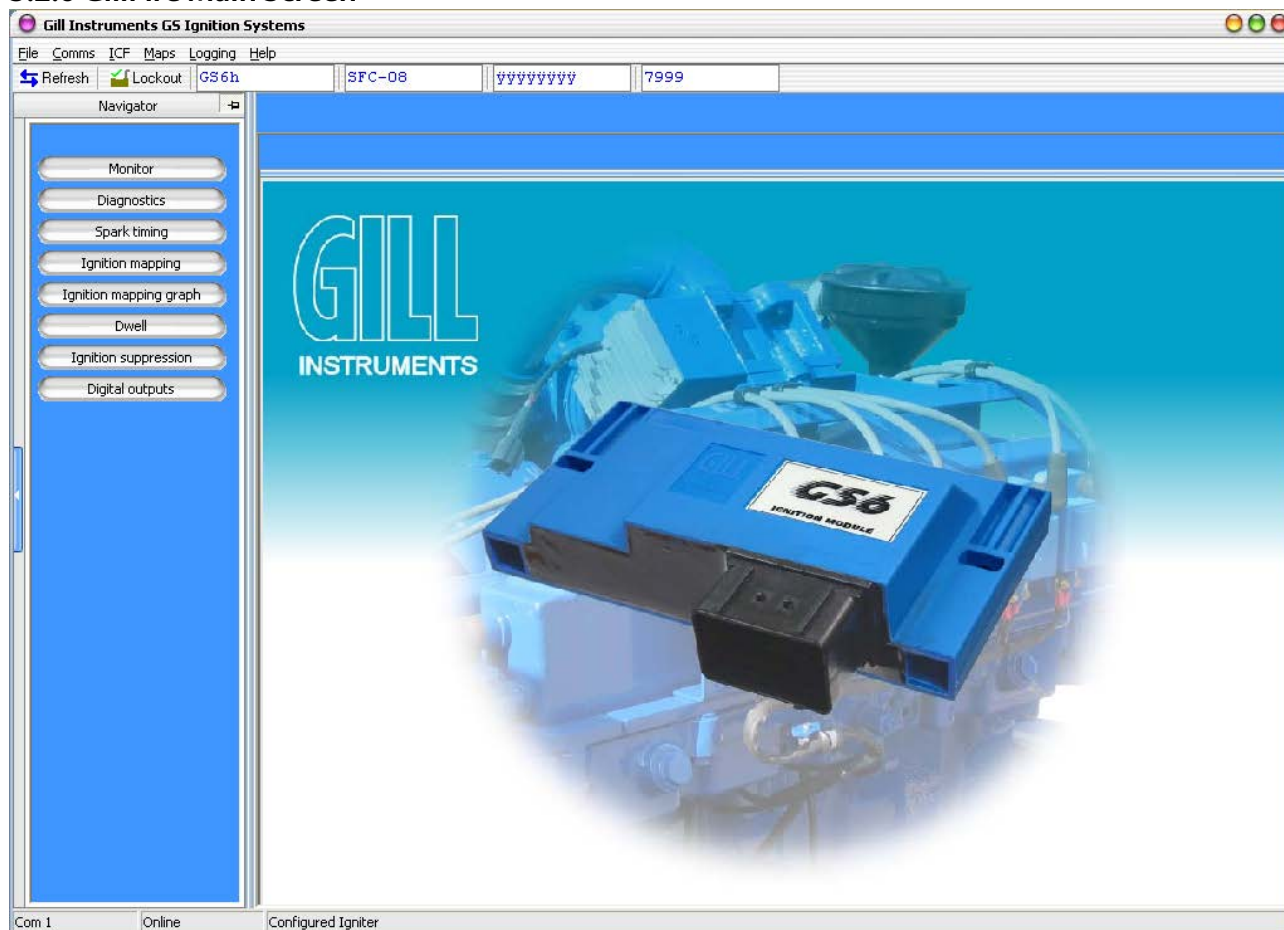

When the Gill-Fire software program is opened, the above screen will appear after a few moments. Note the command line at the bottom of the screen identifies if there is communication with the Igniter.

If there is a communication problem with the Igniter, first select the refresh icon to restate communications. It may be necessary to select the comms tab and select the alternative Comms Port.

### 3.2.7 The Gill-Fire Monitor Screen

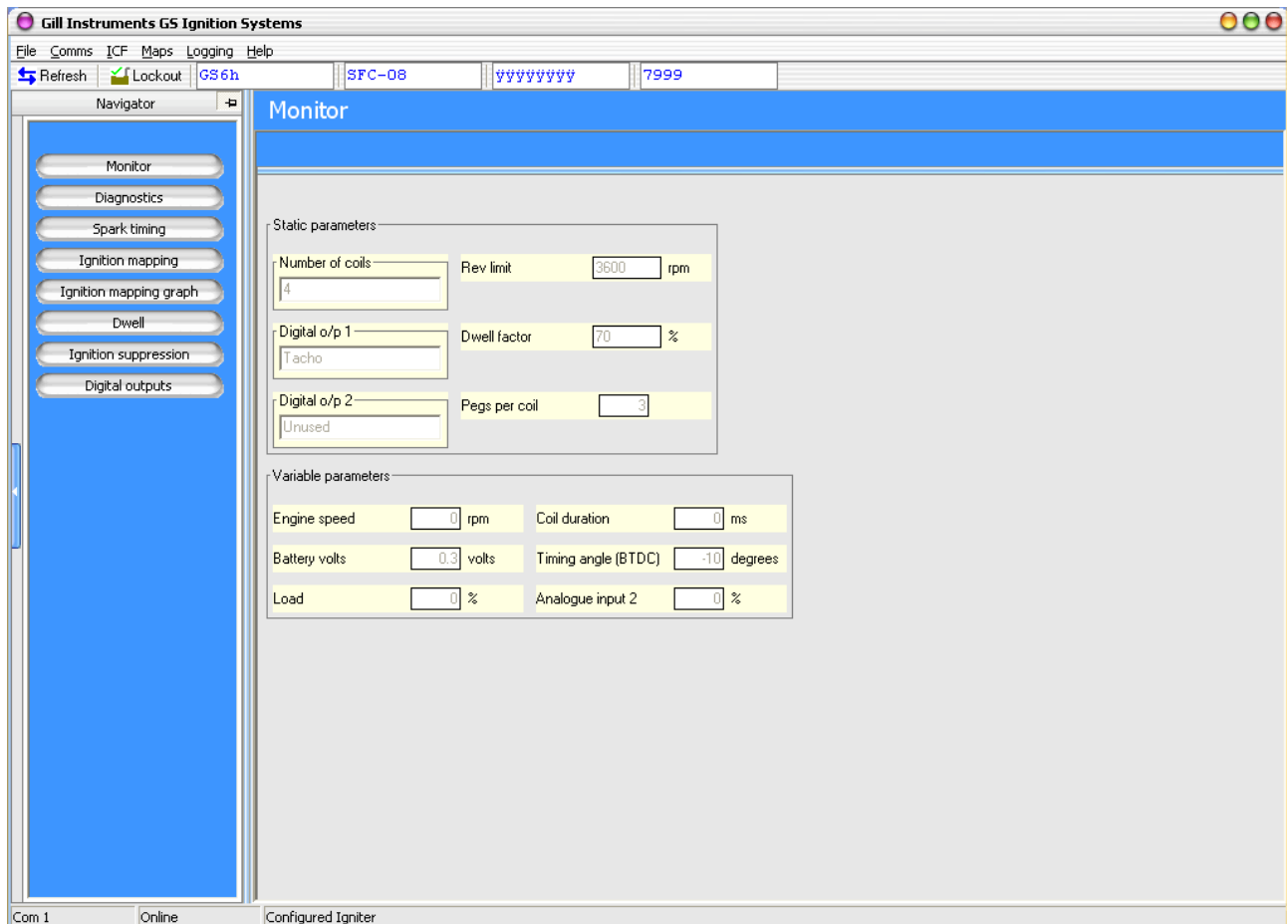

The monitor screen is a reference screen for the following parameters:

The readings displayed in this Panel are generated by the Igniter from various inputs.  
Static Parameters

#### Number of coils

- This is set from the original authority defined settings and is only accessible when the GCF allows access.

#### Digital outputs 1 and 2

- These can be configured (using the digital outputs tab) to drive a tacho, fuel drive or external relay driver for customer specific applications (for tacho the output can be configured for either 1 or 2 pulses per revolution, 2 stroke/four stroke)

#### Rev limit

- This can be set in increments of 10rpm if the system reaches this level the igniter will progressively shut down one coil every 10 rpm over this threshold. The coils will be shut down in reverse order from Coil F to Coil A

#### Dwell factor

- See section 3.2.12

There are other factors, which can be customised by Gill to optimise the use of OEM coils for customer specific applications. Please contact Gill for further information.

**Pegs per coil**

- This denotes the number of timing disc pegs that the igniter is referencing for timing information

**Variable Parameters:****Engine speed**

- Displays current engine rpm

**Battery Voltage**

- This displays the current supply voltage to the igniter.

**Load %**

- This can be configured to show the percentage of load either from a MAP (manifold absolute pressure sensor) or TPS (throttle position sensor)

**Timing Angle (BTDC)**

- This shows the current timing angle which the igniter is using this is a user programmable option available when accessing the ignition mapping screen.

**Analogue input 2**

- This can be configured for additional inputs such as temperature

### 3.2.8 The GillFire Diagnostics Screen

This screen allows the user to view diagnostic data useful for trouble shooting.

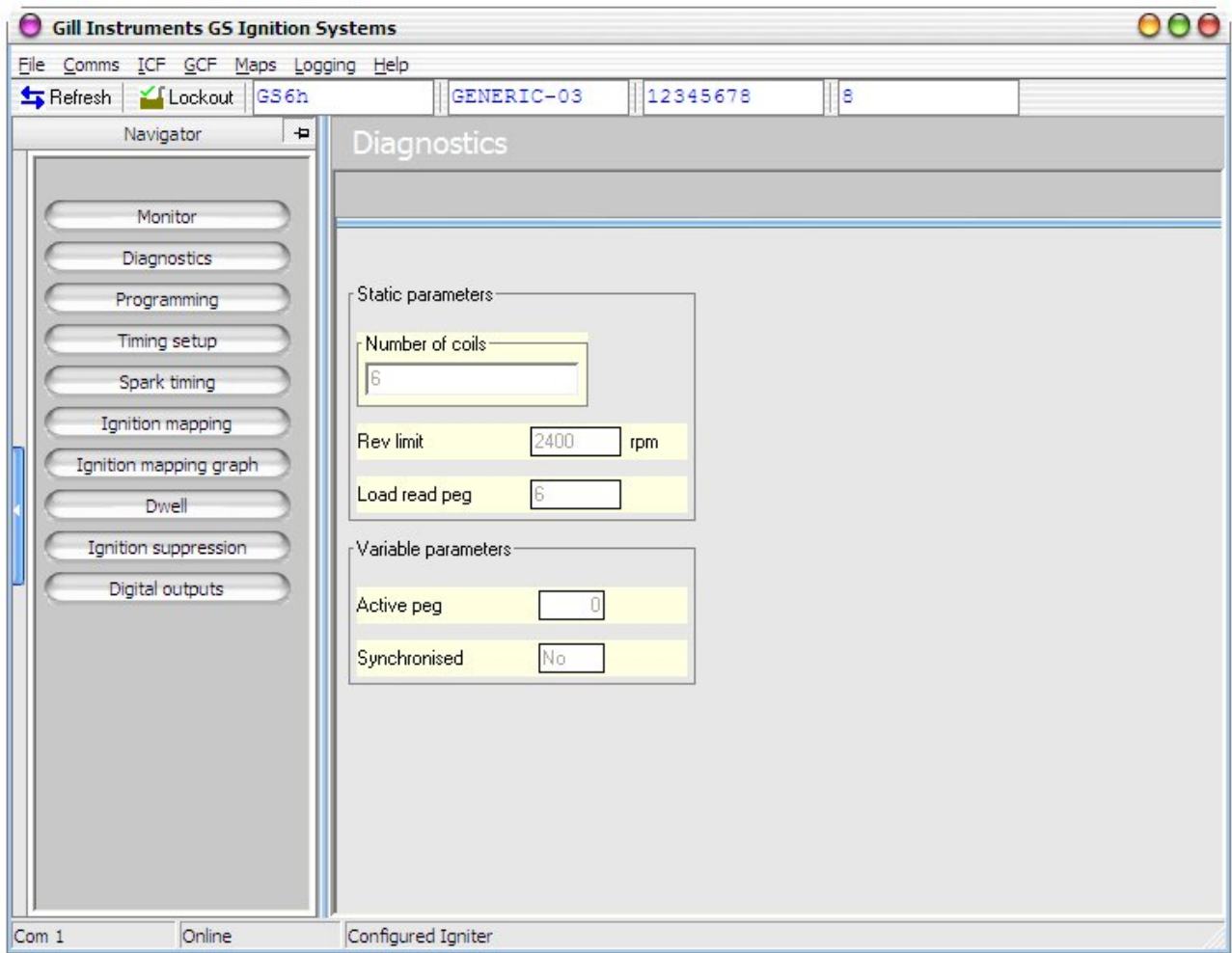

The main reference parameter is **Synchronised**. If the engine is turning with the ignition switch on, and the **Synchronised** parameter is **No**, there is either an issue with the engine position sensor(s) not being position correctly, or a timing disc error. Please contact Gill for assistance.

### 3.2.9 The GillFire Ignition Spark Timing Screen

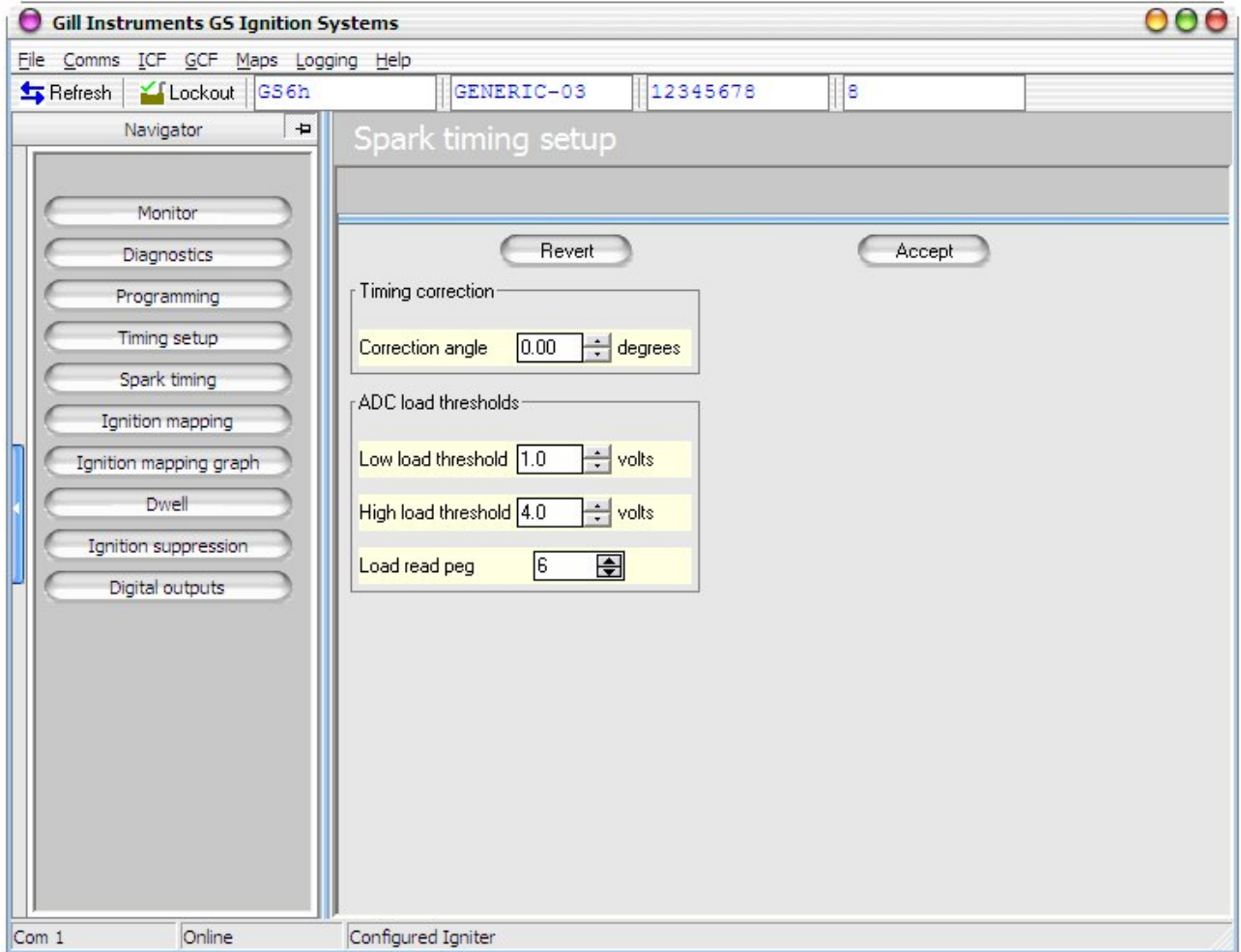

The Spark Timing Screen allows access to the following parameters:

#### Timing Correction

- User can enter in a timing correction to allow for manufacturing tolerances

#### ADC Load Thresholds – Refers to TPS or MAP sensor signal input

- Low Load Threshold – At or below the inputted voltage the igniter will register 0 % load
- High Load Threshold – At or above the inputted voltage the igniter will register 100% load

For instance –      Low Load Threshold – 1.2V  
                              High Load Threshold – 3.8V

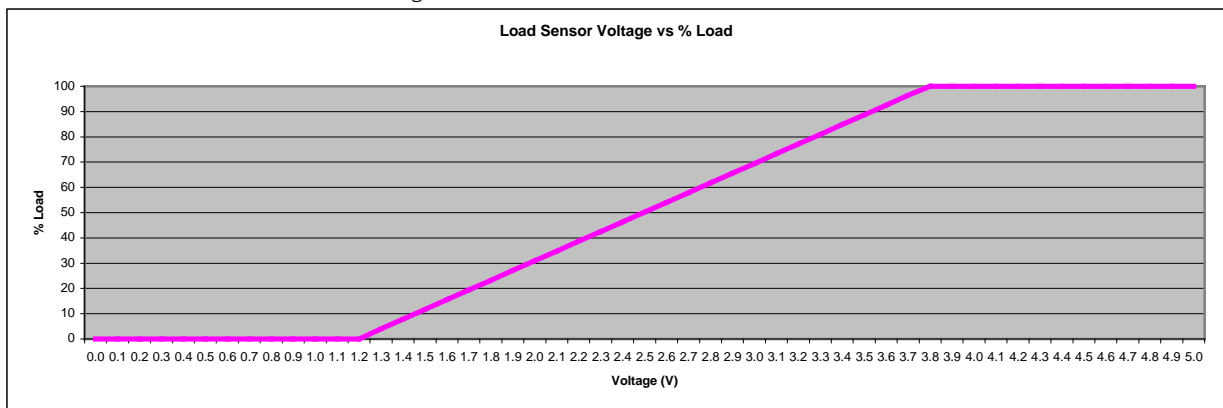

### 3.2.10 The GillFire Ignition Mapping Screen

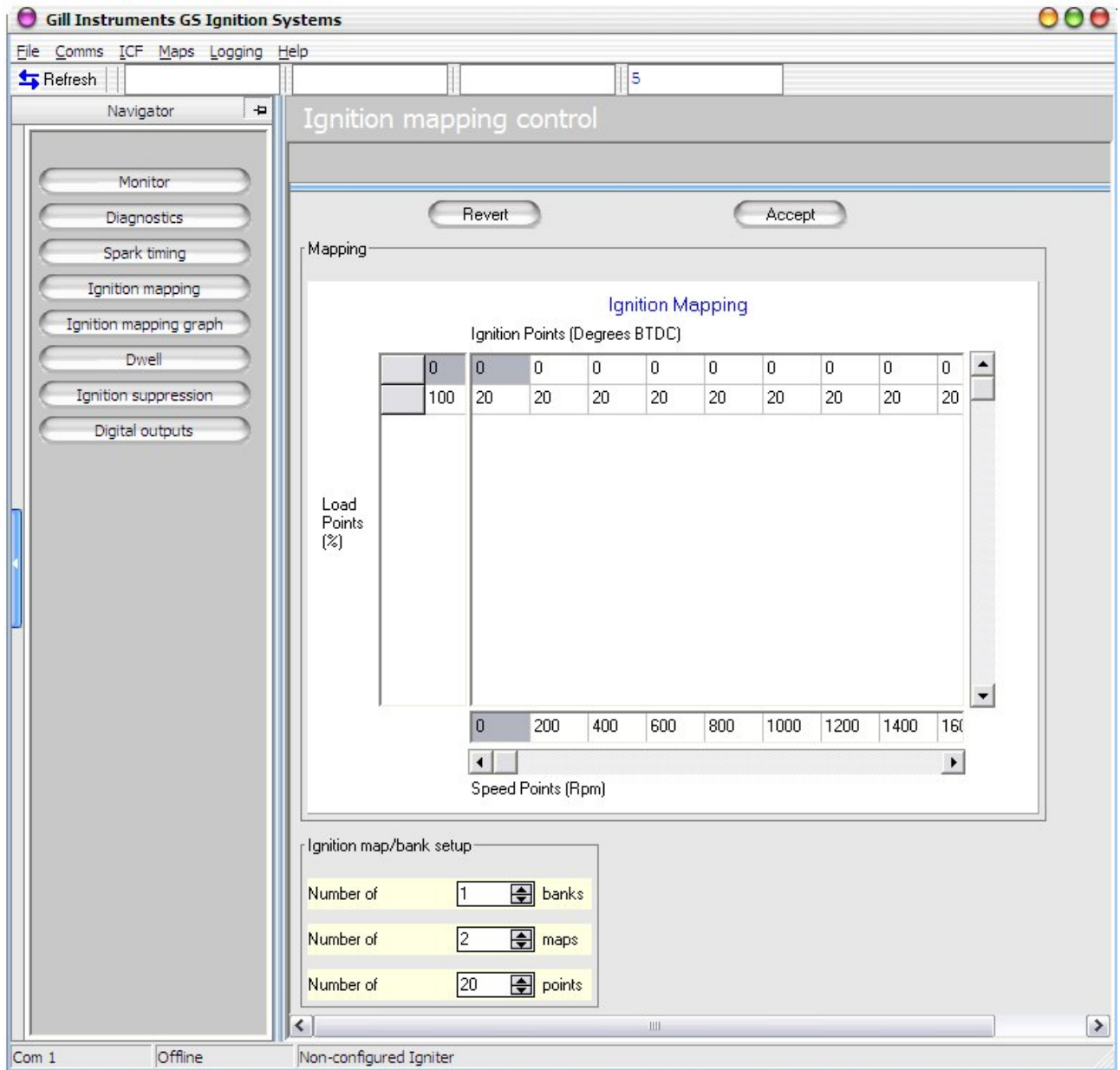

The **Ignition Mapping** screen allows you to program the ignition advance curve(s), set the number of curves for load mapping, load points used, number of rpm points and rpm points used.

The GT6 module is capable of operating with up to 100 points of data that can be arranged in a three-dimensional table, for instance.-

Number of Banks (2) x Load Points (5) x RPM Points (10) = 100 ✓

Number of Banks (5) x Load Points (10) x RPM Points (10) = 500 ✗

## Number of Banks

- Each bank holds a separate set of maps that can be used for different fuel types. These are selected using the 2<sup>nd</sup> 0 – 5 V analogue input, the percentage threshold for switching banks is entered in the box below.

## Number of Maps

- If you are using load mapping each map represents an engine load measured using a MAP sensor or equivalent with a 0 – 5 V signal. The user is able to enter in the load % for each. Therefore if you are using 5 maps they could be configured as –
 

Map 1	-	0% Load
Map 2	-	35% Load
Map 3	-	55% Load
Map 4	-	80% Load
Map 5	-	100% Load

Please see image below for an example –

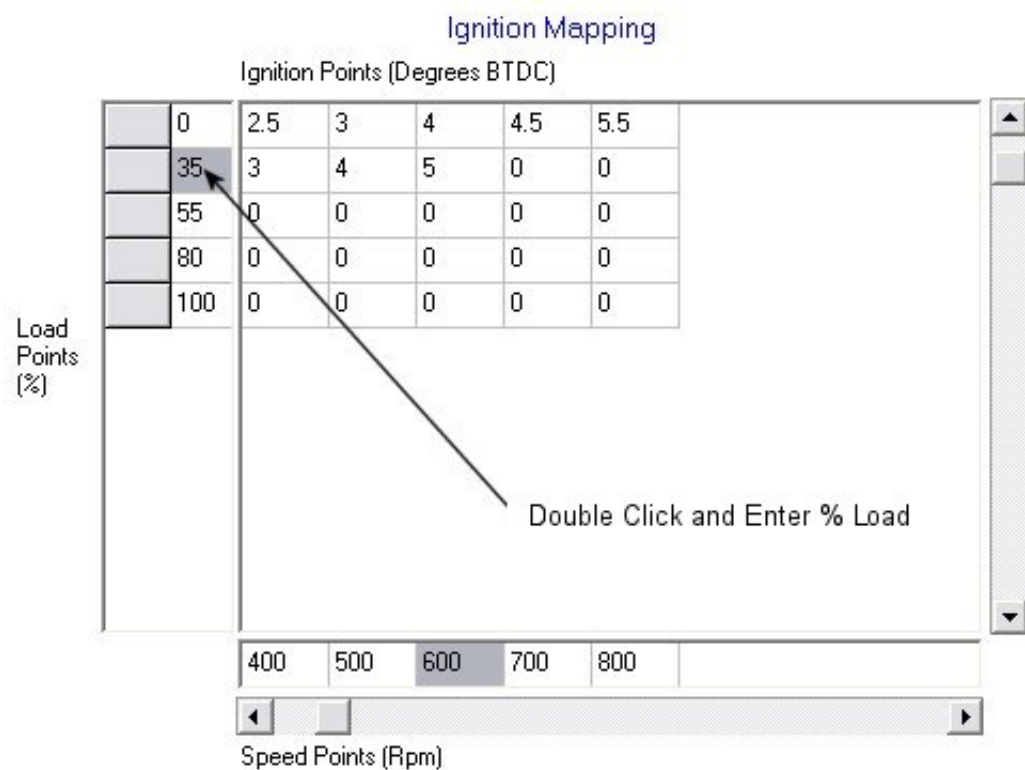

The maximum and minimum threshold values for the load input are set on the Spark Timing Screen; please see section 3.2.9 for details.

## Number of Points

- The number of RPM points used for ignition advance mapping, these are programmable and allow the user to enter input Rpm's such as –

0	Rpm
500	Rpm
1000	Rpm
1400	Rpm
1500	Rpm
1600	Rpm

To change the ignition point (Degree BTDC) simply double click on the relevant entry in the table, input the required ignition point in degrees and press Enter (↵) as below –

**Ignition Mapping**

Ignition Points (Degrees BTDC)

Load Points (%)	0	30	30	30	30	30	30	30
	25	25	25	25	25	25	25	25
	50	20	20	20	20	20	20	20
	75	15	15	15	15	15	15	15
	100	10	10	10	10	10	10	10

Double Click and Enter Ignition Advance

0	500	600	800	1000	2800	3000
---	-----	-----	-----	------	------	------

Speed Points (Rpm)



## 3.2.11 The GillFire Ignition Mapping Graph Screen

Clicking this provides the user with a 2D or 3D graphical representation of the ignition map last selected in the "Ignition Mapping" screen. An example is shown below.

**Please Note:** You cannot make amendments to ignition timing – for this you need to go to the "Ignition Mapping" Screen.

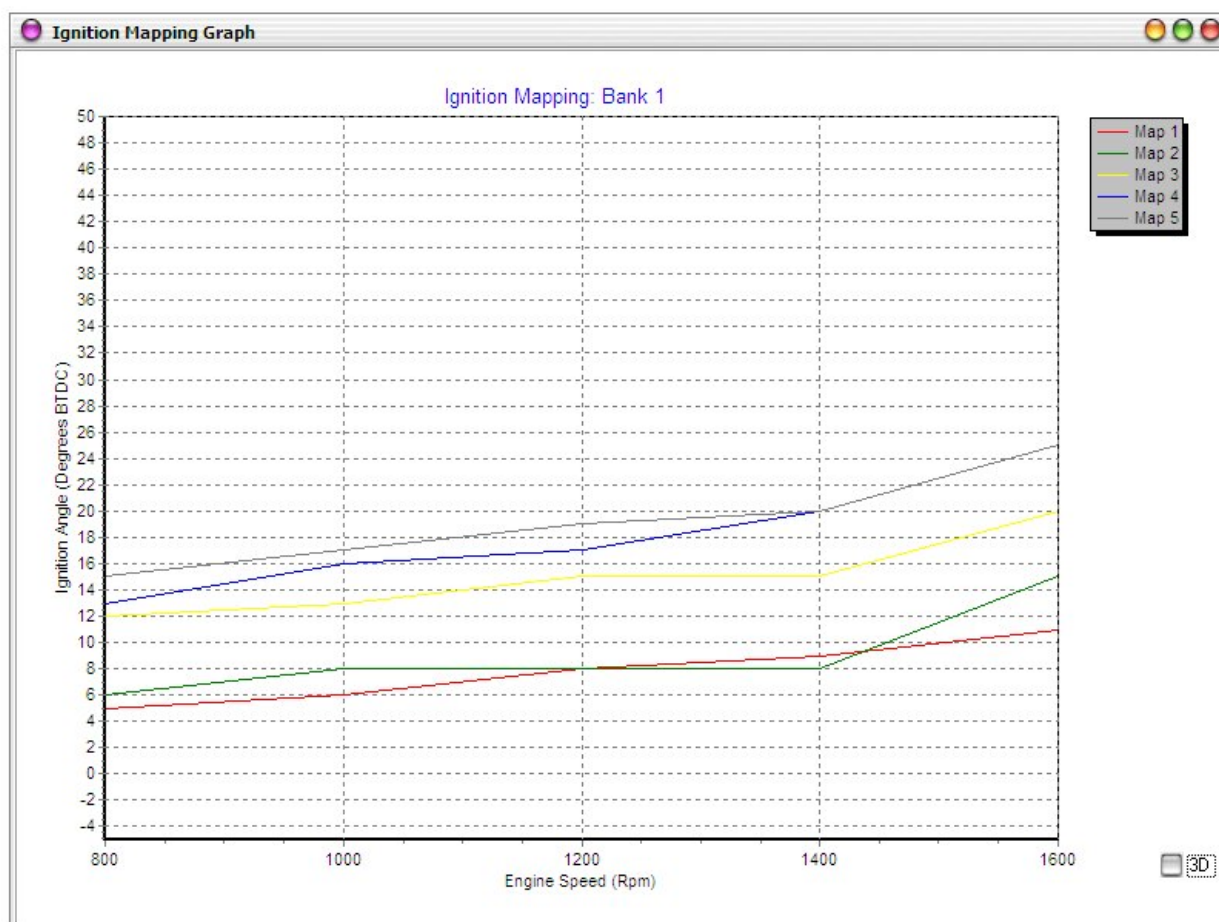

By selecting the 3D box, you will get a 3D representation of the ignition maps.

### 3.2.12 GillFire Dwell Setup Screen

This screen allows the user to change the coil on time – “Dwell” – to optimise combustions and emissions on an engine. The larger the Dwell, the more spark energy is available at the spark plug.

**Please Note:** Please contact Gill before amending this figure.

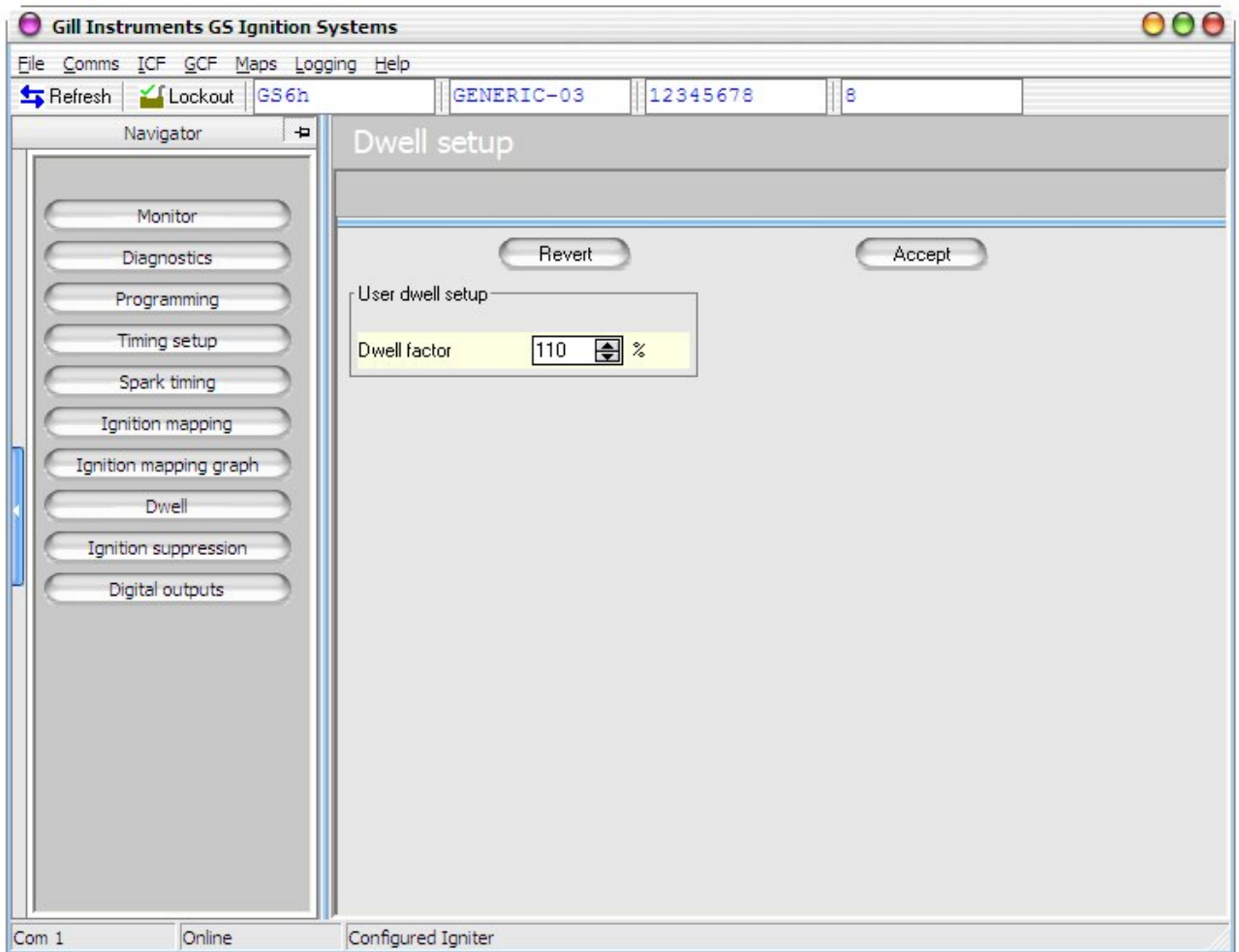

### 3.2.13 GillFire Ignition Suppression Screen

In this screen the User can change the ignition RPM Limit.

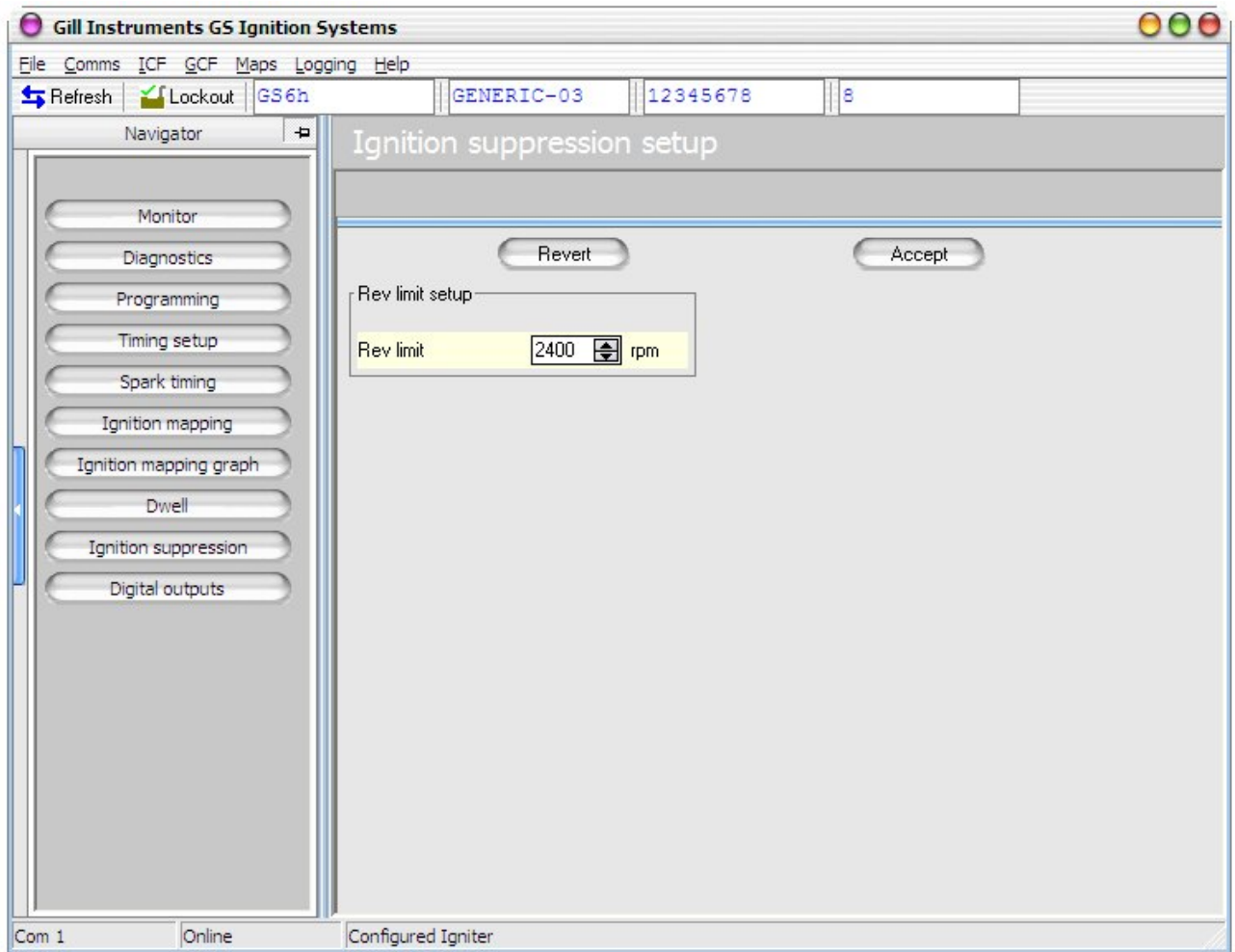

This can be set in increments of 10rpm if the system reaches this level the igniter will progressively shut down one coil every 10rpm over this threshold. The coils will be shut down in reverse order from Coil F to Coil A.

### 3.2.14 GillFire Digital Output Screen

On this screen the user is able to configure the two available digital outputs on the GS6. They are on Pin 10 (Output 1) and Pin 17 (Output 2).

**Please Note:** Output 2 can only be used with single pickup option (One timing disk)

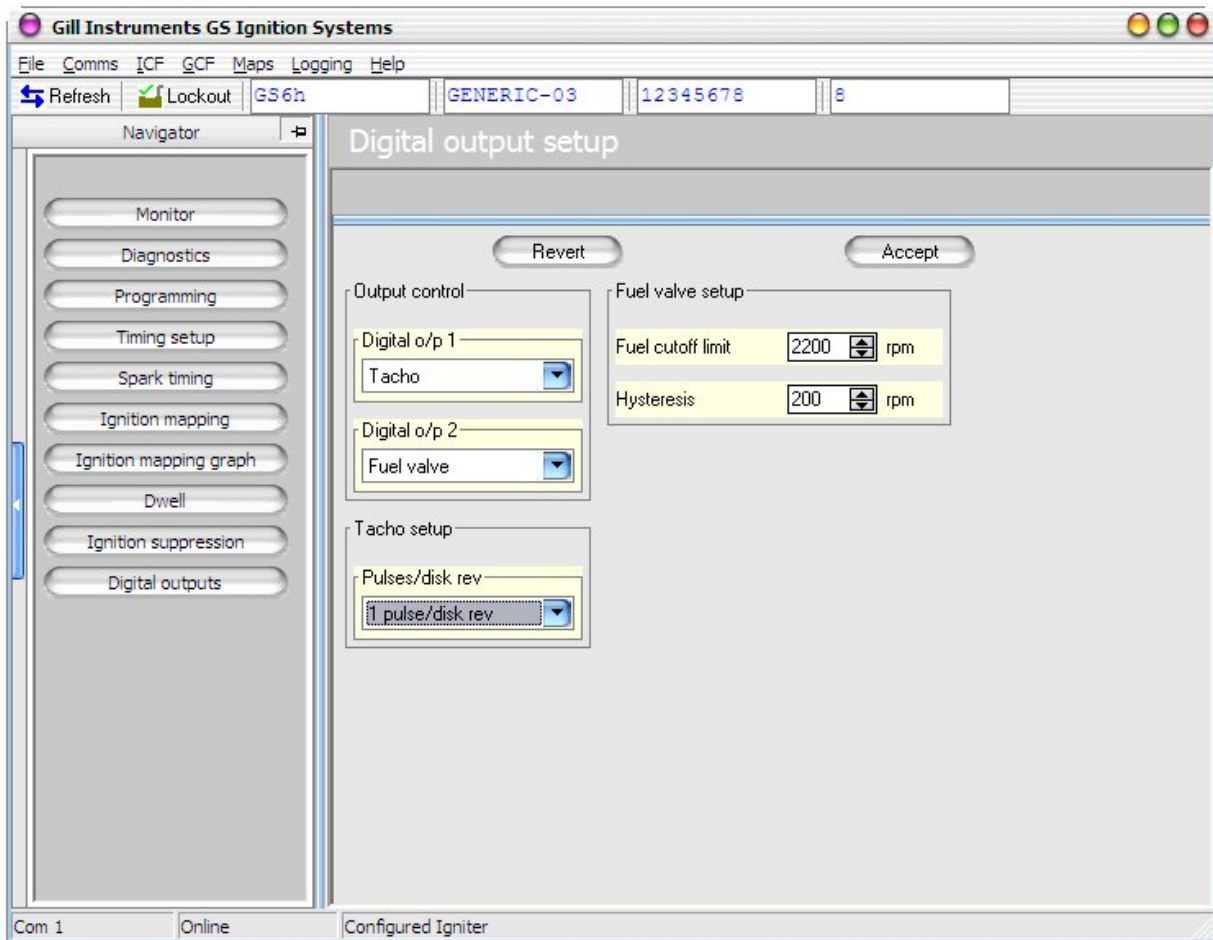

#### Output Control

- The two 0 – 5 volt Digital Outputs are able to be set to –
  - Unused
  - Tacho
  - Fuel Valve

#### Tacho Setup

- The Tacho output can be set to pulse at either once per timing disk revolution or once per two timing disk revolutions.

#### Fuel Valve Setup

- Fuel Cut off limit – Above this limit the relevant digital output will go high, which can be used to switch a fuel valve to shut off the fuel. This limit should be set lower than the ignition rpm limit so that no unburnt fuel is left in the exhaust system or catalytic converter.
- Hysteresis – Once the Fuel Cut off limit has been exceeded the igniter will not set the relevant digital output back to low until the engine rpm drops below -  
Fuel Cut off Limit minus Hysteresis

Therefore if Fuel Cut off Limit = 2,400 RPM and Hysteresis = 200 RPM the digital output will switch on at 2,200 RPM.

#### 4. WIRING DIAGRAM (Igniter Connector Pin-out arrangement)

Note that Pin 1 is located at the bottom right hand side of the Igniter connector (cable entry side). Pins are numbered right to left in each row.

Pin	Description	Comment
1	Coil E	
2	Coil F	
3	Battery -ve	0V (power ground)
4	Load Sensor	TPS or MAP sensor signal input
5	Pickup Input	Inductive Pickup +
6	Pickup Ground	Inductive Pickup -
7	Coil A	
8	Coil B	
9	Battery +ve	Permanent power in (+31V maximum)
10	Output 1	Speed signal or fuel valve drive
11	RS232 TX	
12	RS232 RX	
13	Coil C	
14	Coil D	
15	Sensor Ground	0V for sensors and switches
16	Analogue Input	Temperature Sensor (Thermistor input)
17	In 3 / Out 2	Second Pickup input / Map Select input / Global Retard input / Digital Output 2 (Configurable)
18	Sensor +ve	5V for sensors and switches

Appendix 1 – GT6 Option 1 Wiring Diagram

GILL GS6 OPTION 1 (IND-HALL INPUT) IGNITION SYSTEM WIRING DIAGRAM

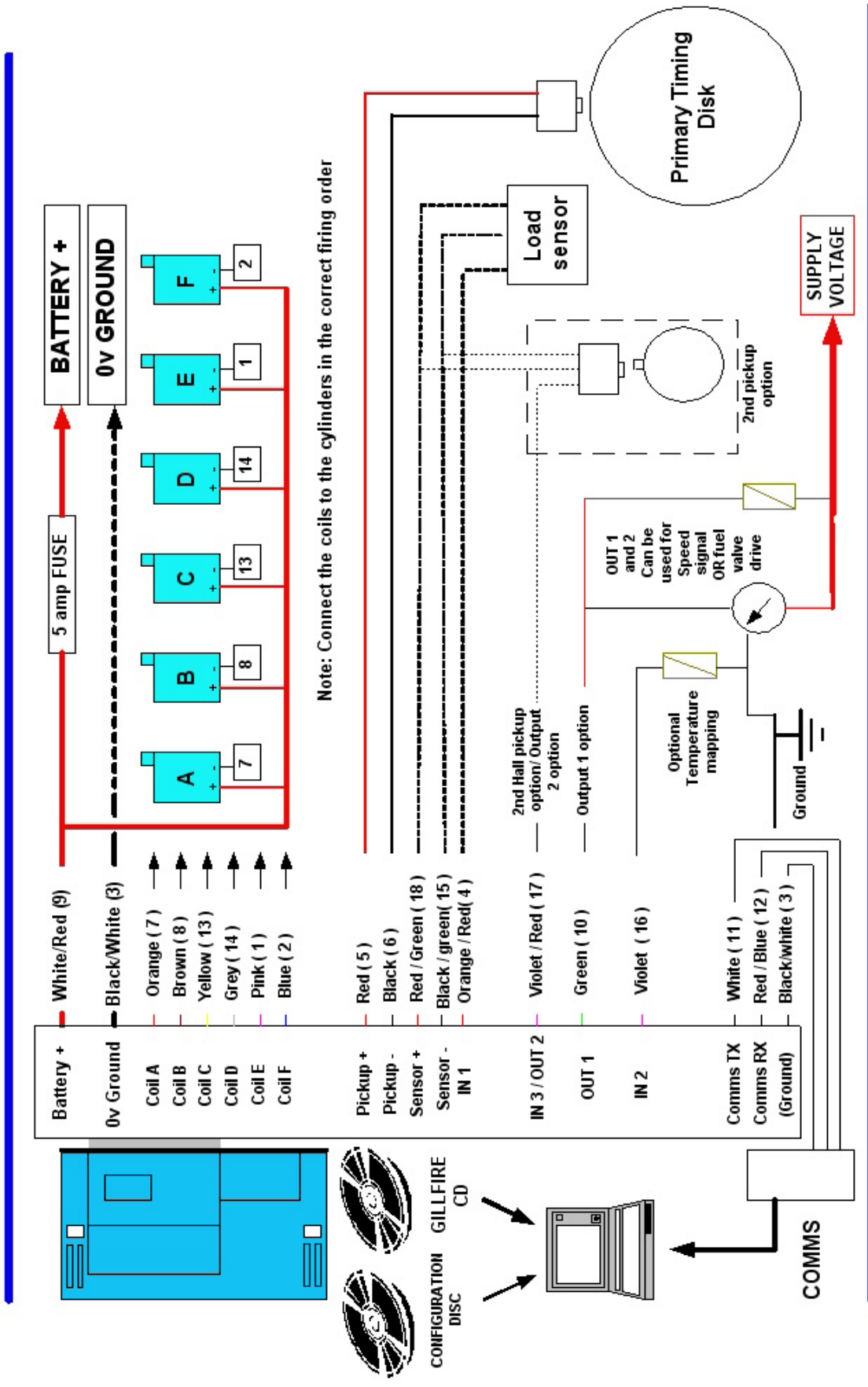

Appendix 2 – GT6 Option 2 Wiring Diagram

**GILL GS6 OPTION 2 (IND-IND INPUT) IGNITION SYSTEM WIRING DIAGRAM**

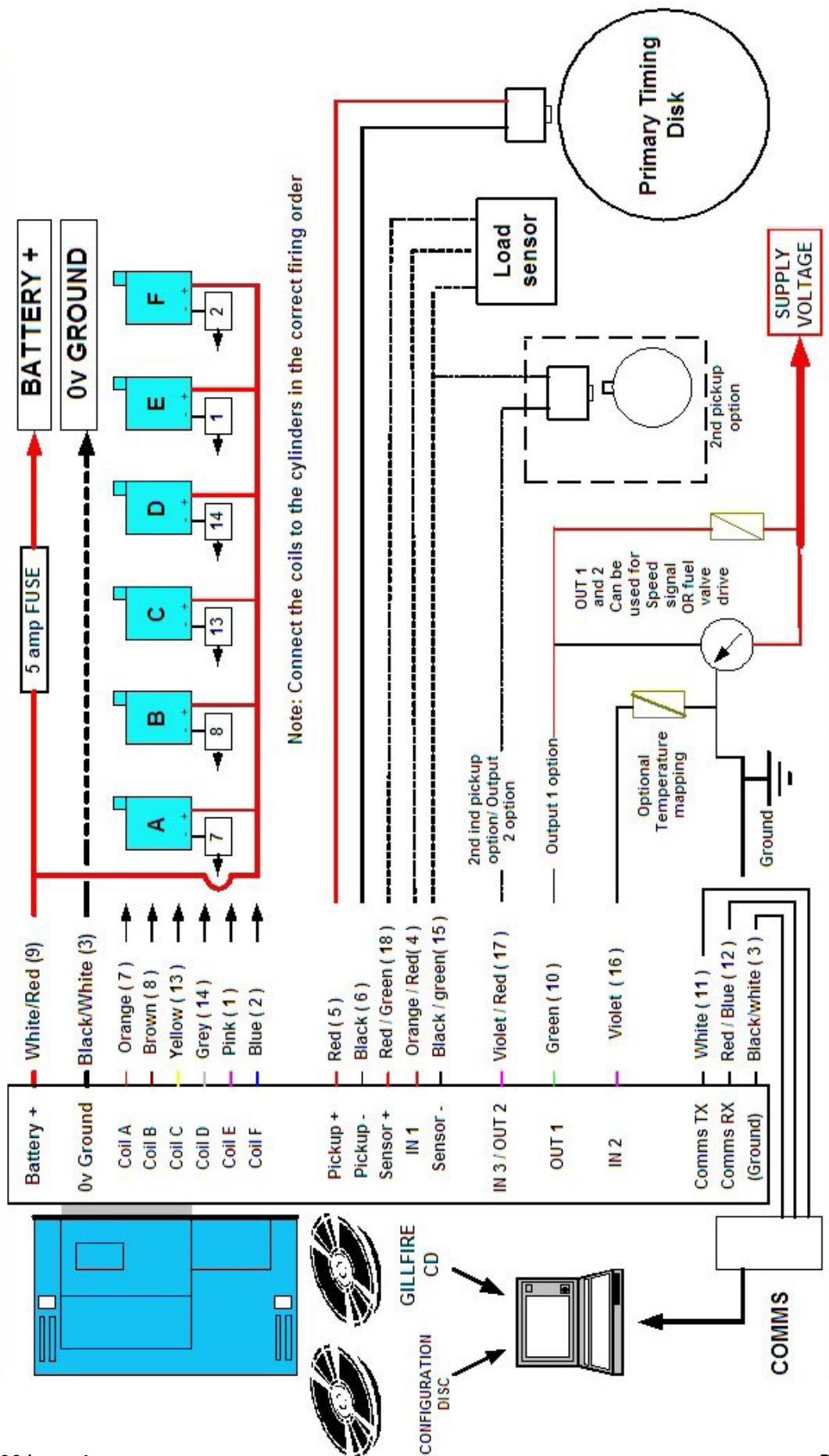



Appendix 3 – GT6 Option 2 Wiring Diagram

**GILL GS6 OPTION 3 (HALL-DIG INPUT) IGNITION SYSTEM WIRING DIAGRAM**

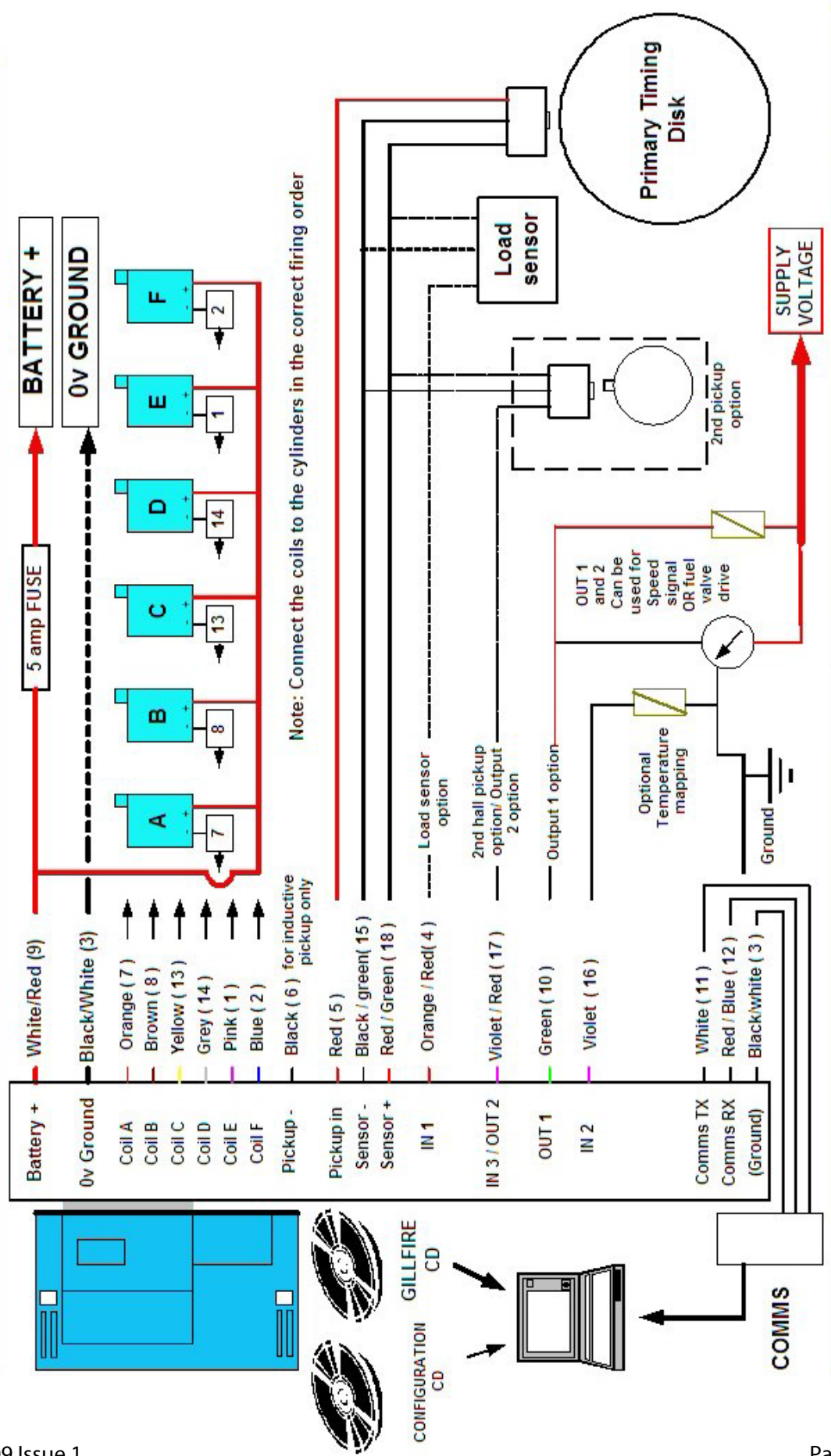





Appendix 5 – GT6 Dimensional Drawing

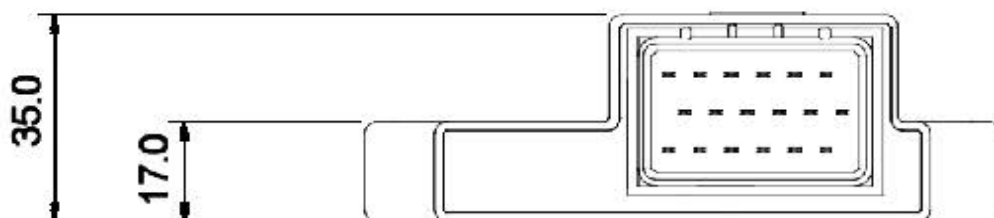
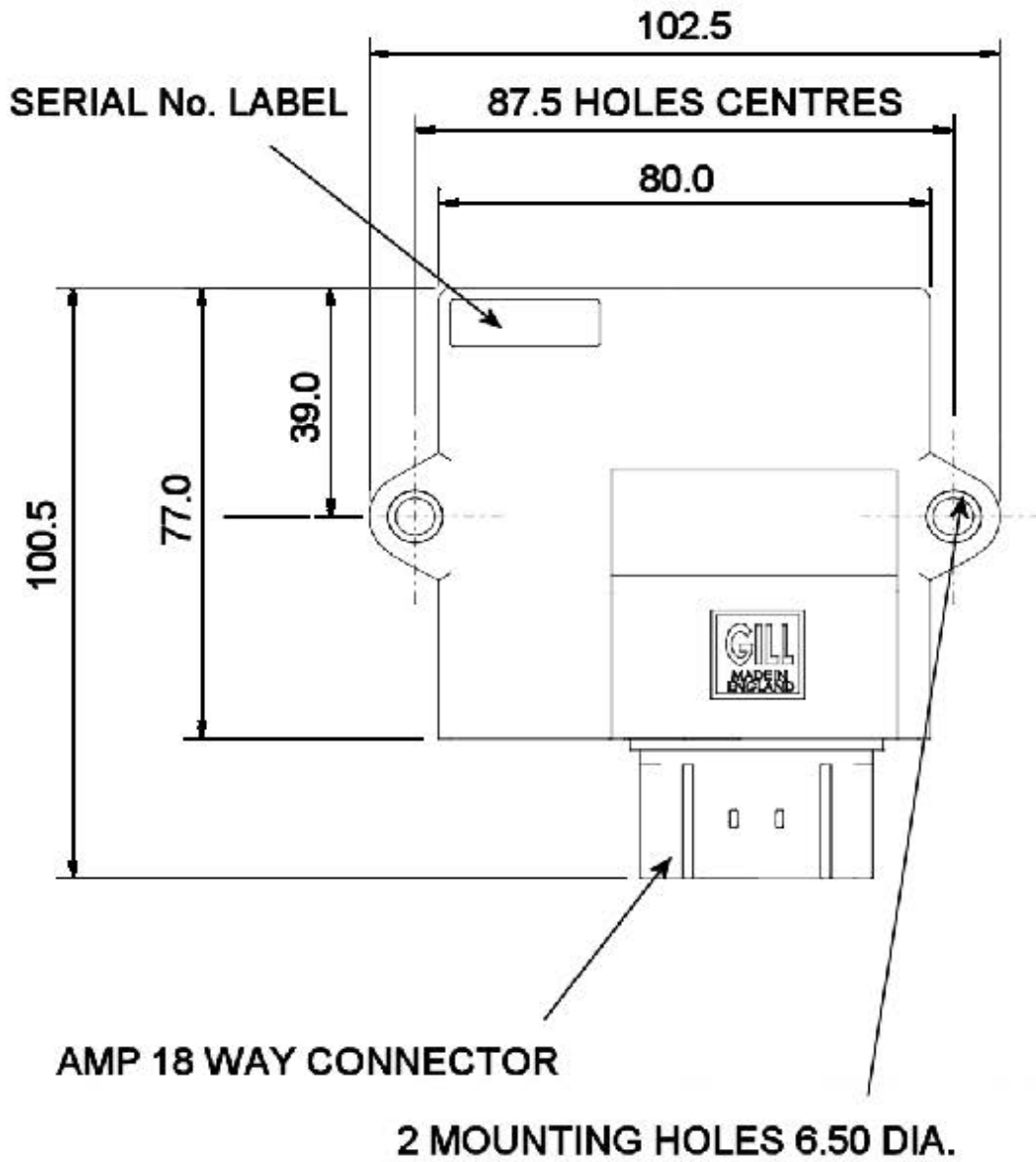

All dimensions in MM