

## Lightweight Liquid Level Sensors

High precision liquid level measurement for specialist applications

LevelLite is a specialist sensor for applications where equipment weight is a priority.

Built from quality aluminium with sealed electronics, and with a range of mounting options, LevelLite offers continuous level measurement in harsh environments like Unmanned Aerial Vehicles where high performance and low weight equal maximum flying time.

Factory calibrated to deliver precise measurement as standard, LevelLite is available with either a switched or temperature output and can be used in fuels, oils and coolants for maximum flexibility of use.

### Typical Applications

- Unmanned aerial vehicles
- Formula 1 motorsports and electric hypercars
- Aero applications

### Key Features

- Lightweight 6082 grade aluminium construction
- Accuracy 1% FSD at 20°C
- Wide operating temperature range  $-40^{\circ}\text{C}$   $+125^{\circ}\text{C}$
- Temperature or switched output options
- Multiple standard or custom mounting options
- Measures high performance fuels, oils and coolants
- Any length available between 100mm—750mm

### Benefits

- Lightweight sensor using high grade components
- Compact design for tight spaces
- Continuous level measurement with secondary alarm output
- Solid state electronics for long life in harsh conditions
- Accurate results from irregular shaped tanks
- No moving parts to maintain
- Factory calibration for precision and easy installation
- Proven in exacting applications - motorsport and aerial vehicles



Lightweight sensor



Multiple mounting options

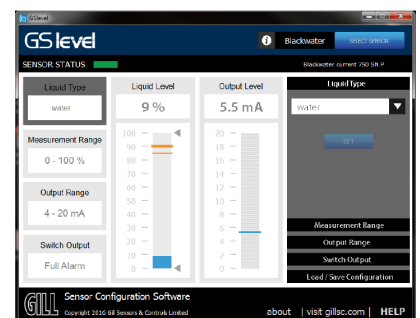

Calibration software

## Lightweight Liquid Level Sensors

High precision liquid level measurement for specialist applications

PRIMARY OUTPUT	
Standard Range	0.25—4.75V (See drawing Datum A—B)
Maximum Range	0.25—10V (See drawing Datum A—B)
Accuracy	+/- 1% @ 50% FSD (Full Scale Deflection) 20C
Volumetric Output	Configurable through GSlevel software Tank profiling wizard or CSV file upload

ELECTRICAL	
Supply Voltage	5—32v DC
Supply Current	<20mA
Data Interface	RS232 (USB-RS232 adaptor available)
Measurement Resolution	10 bit (1024 bits over range)
Sample Rate	100Hz

ENVIRONMENTAL	
Ingress Protection	IP68
Shock	BS EN 60068-2-27 (half sine pulse 25g, 6ms 1000 shocks (positive & negative) in each 3 axis)
Vibration	Resonant frequency search 5 to 2500Hz @ 0.5g peak
Pressure	10 bar (absolute and differential)
EMC	EN 610000, EN61326, EN 60945
Thermal Shock	BS EN 60068-2-14, test Na
Dry Heat	BS EN 60068-2-2 test Bb
Cold	BS EN 60068-2-1 test Ab
Damp Heat	BS EN 60068-2-30 test Db
EMC	BS EN 60945, BS EN 61326 & BS EN61000-6 -1/2/3/4

This product is not designed or certified for use in ATEX environments







DIMENSIONS (SUMMARY)	
Total Sensor Length	Probe length + 12mm flange height
Mounting Flange Height	12mm (excl. cable)
Mounting Flange Ø	34mm (excl. mounting bracket)
Measurement Length	Probe length minus 7mm

ORDERING	
<p><b>Length Range (mm):</b> 1 = 100 - 250 2 = 251 - 500 3 = 501 - 750</p> <p><b>Cable Exit:</b> S = side exit T = top exit</p> <p><b>Secondary Output:</b> Y = temperature N = switch</p> <p><b>Sensors</b></p> <p>4223 - 00 - <input type="text"/> <input type="text"/> <input type="text"/> - <input type="text"/> <input type="text"/> <input type="text"/></p> <p><b>Exact Length (mm):</b></p>	

SECONDARY OUTPUT	
Switched (Option N)	Open collector output 50V / 1A max switch to ground (V-)
Hysteresis (Option N)	Configurable through GSlevel
Temperature (Option Y)	0.25-4.75V (0.25v = -40C, 4.75V = +125C) (not configurable through GSlevel)
Temperature Accuracy	+/- 1.5°C (0°C—125°C) +/- 2.0°C (-40°C—0°C)

MECHANICAL	
Lengths Available	100—750mm in 1mm steps
Mounting Options	1 hole, 2 hole, 3 hole, 5 hole & M22 x 1.5 threaded
Sealing Options	Panel gasket or O-Ring
Cable	Flying lead, 1000mm
Cable Cores	6 with drain wire
Wire Size	26AWG 7/0.15
Wire Sleeve	XLPE
Cable Exit Options	Top or Side
Weight (excl cable)	48g (100mm probe + 0.256g/mm)
Cable weight	0.024g/mm

LIQUIDS	
Fuels	Diesel, Gasoline, Biofuels
Oils	Hydraulic, Gear, Motor, Vegetable, Syn- thetic Ester, Polyalphaolefin, Polyglycol
Coolants	Ethylene Glycol, Water
Other	Salt Water

CONNECTIONS		
	RED	+V (5-32VDC)
	BLACK	-V (GROUND)
	ORANGE	Primary output (0.25 to 4.75VDC)
	BLUE	Secondary output (refer to datasheet)
	GREEN	RS232 Rx line
	WHITE	RS232
	SILVER	Drain Wire

## Lightweight Liquid Level Sensors

High precision liquid level measurement for specialist applications

### DETAILED DIMENSIONS (SENSOR—ALL VERSIONS)

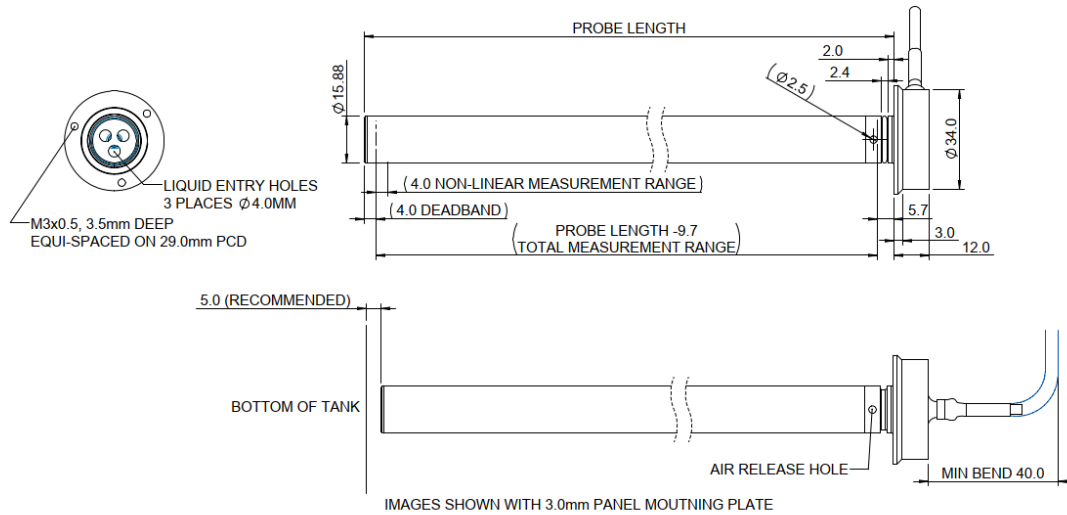

### DETAILED DIMENSIONS (MOUNTING OPTIONS)

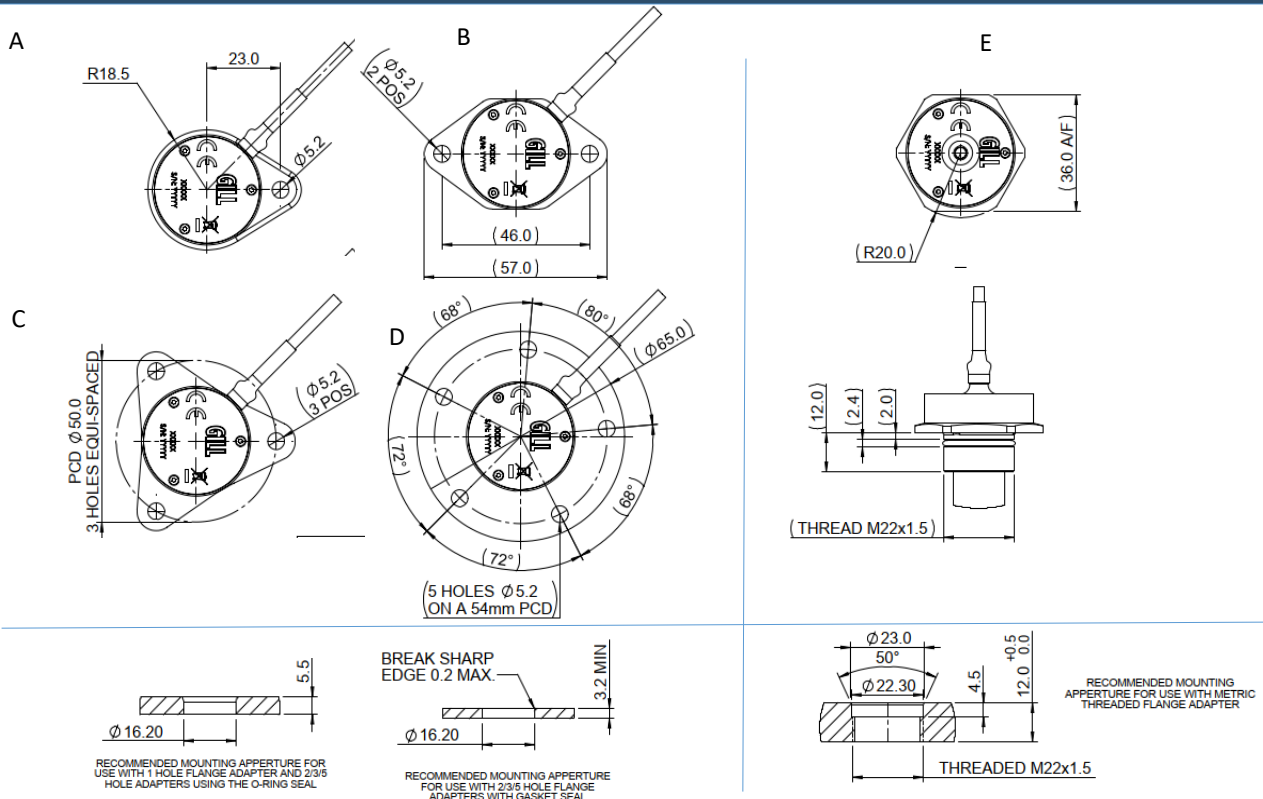

For more information about LevelLite please contact Gill Sensors & Controls.

[gillsc.com](http://gillsc.com)