

WearDetect

Oil Debris Sensor

User Manual

Sensor with display

4212-PK-145
4212-PK-146
4212-PK-147



Sensor without display

4212-PK-148
4212-PK-149
4212-PK-150
4212-PK-151



Inflow fitting

4212-00-160-100
4212-00-160-150
4212-00-161



Contents

1. Welcome	4
1.1 Thank you for Purchasing	4
1.2 Overview of Content	4
1.3 General Notes	5
2. Product overview	6
2.1 Description of the Product	6
2.2 Purpose	7
2.3 Product Range	7
2.4 Fitting Adaptors	7
2.5 Sensor software	8
2.6 Optional Inflow Fitting	8
2.7 Accessories	9
3. Set up WearDetect	10
3.1 Introduction (with/without display)	10
3.2 Software	10
3.3 Connections (with / without display)	10
3.4 Oil Calibration Bench Test	12
3.5 Debris bench test	12
3.6 Bench set up	12
4. Install WearDetect	14
4.1 Sensor Location	14
4.2 Sensor Head	15
4.3 Sensor Electronics	17
4.4 Sensor Cabling	18
4.5 Connections (with / without display)	19
4.6 Sensor Inflow Installation	21
5. Use WearDetect	23
5.1 Configuring the sensor	23
Full Scale Fine	26
5.3 Manual Adjustment	29
5.4 Oil Calibration	29
6. Sensor Head	35
6.1 Cleaning	35
6.2 Servicing	35
6.3 Software	37
6.4 Sensor De-commissioning	37
Appendix A	38
Appendix B	46
Appendix C	51
Appendix D	52
Appendix E	53

1. Welcome

1.1 Thank you for Purchasing



Thank you for purchasing WearDetect. This manual provides all the necessary information to get the best results from the product. Please visit www.gillsc.com for the latest version of the manual alongside additional information on the product. Please read through the manual fully before setting up and installing the product.

1.2 Overview of Content

This manual is separated into 6 sections, each representing an activity in the use of the product. Additional detailed information is contained in the Appendices at the end of the manual.

- Section 1 covers how the manual is set out.
- Section 2 provides a brief overview of the product
- Section 3 provides information needed to set up the product
- Section 4 provides the information needed to install the product
- Section 5 provides the information needed to use the product
- Section 6 provides guidance for product maintenance and fault finding

This manual uses icons for illustration purposes as follows;

Icon	Description
	A note that is important and that should be observed
	Information or a recommendation to ensure best results
	The start of a set of instructions

WearDetect

Oil Debris Sensor

1.3 General Notes



Before WearDetect is used for the first time, it is highly recommended to read and understand this manual. Please keep the manual safe for future reference.



Care should be taken when transporting the unit, using the supplied packaging, to avoid the sensitive electronics and sensing components being subjected to environmental conditions they are not designed for.



During set up and installation, please ensure the product is supported, the correct equipment is used and general handling practices for the sensor are observed (see Section 5).



Maintenance should be limited to the procedures described in this manual. Additional maintenance or cleaning may damage the sensors.



No attempt should be made to open or repair any of the parts of the product sensor head assembly. Any attempt to open this part of the product will invalidate the warranty provided by Gill Sensors & Controls.



Gill operates a policy of continuous improvement and as such reserves the right to change product details in line with this.



CAUTION: The sensor head assembly contains strong magnets. Any sensitive objects or devices (including pacemakers) should be kept away from the sensor head.

WearDetect

Oil Debris Sensor

2. Product overview

2.1 Description of the Product

WearDetect is a condition monitoring sensor that detects particles of ferrous metal in oil. Deposited metal particles in the oil from gears, bearings or other metal contacting surfaces are used to indicate an overload condition, providing an early indication of mechanical failure.

Each WearDetect contains four sensors, as follows;

- Ferrous Fine debris
- Ferrous Coarse debris
- Temperature and Oil Presence.

The ferrous metal sensor uses a permanent magnet to measure based on the volume of material collected by the sensor, quantifying it as "fine" or "coarse" in size, reporting a signal associated with the volume of each debris type.

The temperature and oil presence sensor uses dielectric measurement to show a significant change in the dielectric value of the oil. Such changes will occur if the oil is not present (oil leak) or if there is a significant presence of water (above 10%).

The following diagram illustrates the type of debris and how it is attracted to the sensor.



WearDetect with coarse and fine debris attracted to the sensor head face.

1. Fine debris only



Fine debris will report the amount of wear particles on the probe face, up to 0.5 g approx.

2. Coarse debris only



Coarse debris will report the amount of chippings on the probe face.

3. Coarse & fine debris

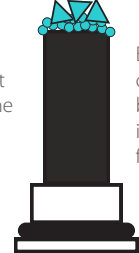

Both reported but coarse debris may be to a lesser extent if held off probe face by fine debris.

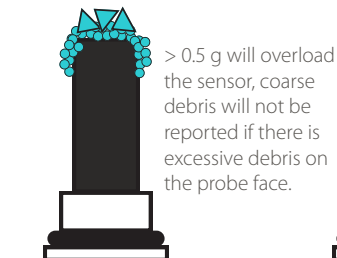

> 0.5 g will overload the sensor, coarse debris will not be reported if there is excessive debris on the probe face.

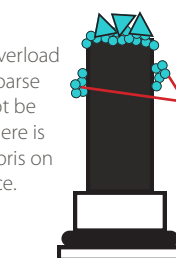

Debris sides will not be reported.

Only the debris on the probe face will be reported.

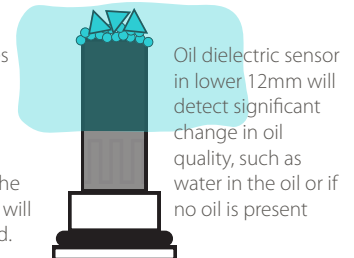

Oil dielectric sensor in lower 12mm will detect significant change in oil quality, such as water in the oil or if no oil is present

4. Debris overload

5. Debris placement

6. Oil Sensor*

* Please note this functionality is not available to sensors using an NPT fitting.

WearDetect

Oil Debris Sensor

2.2 Purpose

WearDetect is designed to provide an early indication of wear to internal components within the lubrication circuit of rotating equipment. This can be from gears, bearings or other metal components subject to contact in operation. As these components are hidden, wear can go unnoticed until a mechanical failure is experienced and an interruption to operations is encountered. WearDetect is designed to alert ahead of these events, avoiding expensive downtime in operations.

2.3 Product Range

The WearDetect range consists of 2 models offered with different electrical outputs

Sensor without local display



4212-PK-148	Oil Debris Sensor 4-20mA
4212-PK-149	Oil Debris Sensor 0-10v
4212-PK-150	Oil Debris Sensor CAN
4212-PK-151	Oil Debris Sensor Modbus

Sensor with local display



4212-PK-145	Oil Debris Sensor with display 4-20mA
4212-PK-146	Oil Debris Sensor with display 0-10v
4212-PK-147	Oil Debris Sensor with display CAN

2.4 Fitting Adaptors

WearDetect is designed to fit into the lubrication circuit of a wide range of equipment types. Most often installed into an oil sump, replacing the sump plug, the sensor can optionally be installed into an oil bypass circuit.

To cater for the different sizes of sump plug found, Gill offer a range of the most popular thread adaptors, one of which must be chosen alongside selecting the sensor for correct installation.

As standard each sensor is supplied excluding the fitting adaptor to allow maximum flexibility at installation.

The following types of adaptor are supplied in a range of sizes.

Please see the product data sheet for more details on the sizes available.

- Metric
- BSPP
- UNF
- NPT

The fitting adaptor is secured to the sensor head via grub screws to aid future maintenance. (See adaptor instructions for more details)



Sensor head with separate thread fitting

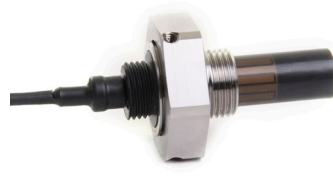

Sensor head with thread adaptor fitted

2.5 Sensor software

To optimise the sensor operation for your installation, Gill recommed using the Weardetect sensor configuration software.

Using this software enables the user to;

- Select & de-select sensor channels
- Review instant measurements from each selected sensor parameter (when connected)
- Set operating parameters for the sensor
- Import or Export a sensor configuration
- Reset the sensor

2.6 Optional Inflow Fitting

Weardetect can optionally be fitted into an oil bypass circuit and Gill offer two kit types for doing this. Shown below, the Inflow adaptor is a 1.5" 'T' piece adaptor for mounting the sensor into.



Also shown below is the Inflow installation kit. These kits contain the adaptor plus isolation valves and supports and can be supplied for either 1" or 1.5" pipe diameters.

These options require the sensor to be fitted with an M20 x 1.5 fitting available from Gill - part code 4212-PK-502, 4212-00-160-100 & 4212-00-160-150

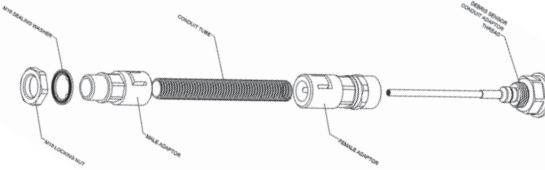

2.7 Accessories

The following accessories are available for use with the sensor as follows;

<p>Debris Strip 4212-00-063</p>	<p>Used for calibrating the sensor</p>	
<p>Conduit Kit 4212-10-051-X</p>	<p>Used to protect the cable on models with the display</p>	
<p>Thread Kit 4212-PK-381</p>	<p>kit of ten thread adaptors</p>	
<p>Tool Kit 4212-PK-382</p>	<p>Installation Tool Kit</p>	

WearDetect

Oil Debris Sensor

3. Set up WearDetect

3.1 Introduction (with/without display)

WearDetect can be installed and operated using the factory installed settings (see Appendix B).

However, Gill recommend setting up the product using the sensor software (see www.gillsc.com/support) prior to installation when possible.

This section provides details on how to set up the sensor and is split into the following ;

- Software
- Connections
- Bench Test

3.2 Software

Download the sensor software from www.gillsc.com/downloads on a compatible computer that can also be connected to the sensor over USB connection.

Please observe minimum system requirements as follows;



- 32-bit (x86) or 64-bit (x64) processor
- Windows® 7 or later
- 1 Gb RAM
- 500 Mb disk space

3.3 Connections (with / without display)

Power supply

See section 5 Specifications, for the applicable power supply ranges appropriate to your model variant.

Connect the sensor to power and to the computer running the downloaded software using the supplied USB cable as follows;

	Wire Colour	Designation
	Black	Power Gnd (V-)
	Red	Power (V+)

WearDetect

Oil Debris Sensor

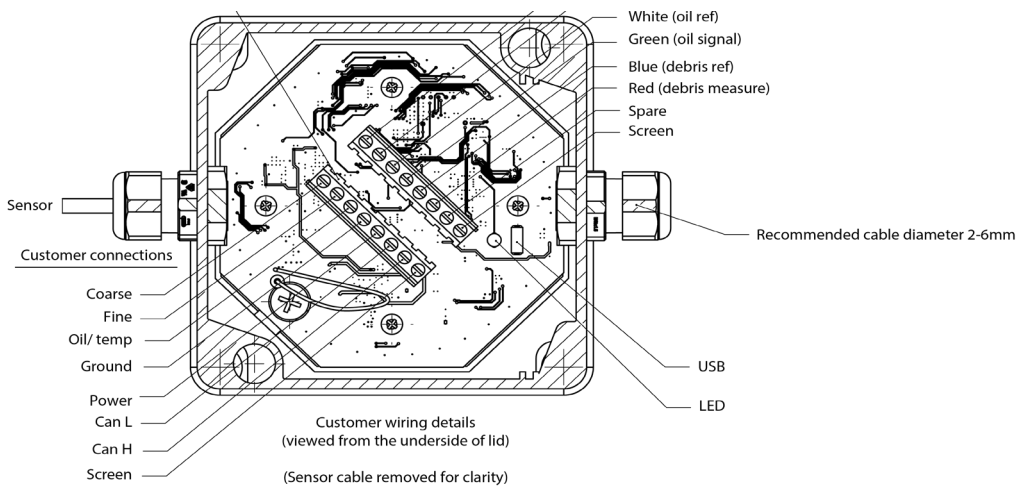

Connections - Sensors with display



Connections - Sensors without display

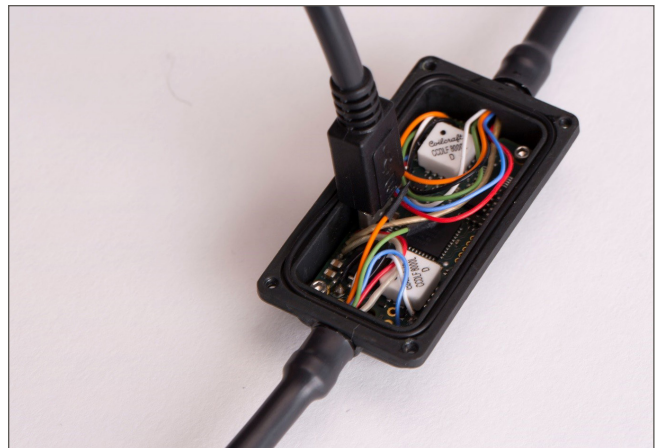

FTDI Drivers

Once connected, your computer may automatically recognise the Oil Debris Sensor; if not you may be prompted to search for FTDI driver software, in which case allow your Windows® software to automatically search Windows® Updates for the drivers. Note: an internet connection is required to obtain driver updates.

For manual installation of the FTDI driver software, follow the steps below:

FTDI drivers can be downloaded at <https://ftdichip.com/drivers/vcp-drivers/>

Open Control Panel>Device Manager and select the unidentified USB serial port from the list and click the right hand mouse button to select 'Properties' from the drop down menu. Select the Driver tab > Update driver select > Browse my computer for driver software and select the folder location of the FTDI driver that you downloaded. Select the folder and click 'Next' to update the driver. The FTDI driver should now be installed.

3.4 Oil Calibration Bench Test

A bench test of sensor functionality is recommended prior to installation. Having connected the sensor to power and through USB to the computer, carry out the following in the software.

From the sensor software Home screen menu select

- ▶ Sensor
- ▶ Restore Factory Defaults

Parameter	Sensitivity Scale		
	Small	Medium	Large
100% FSD Coarse	1 x 3mm Chrome steel ball bearing	1 x 5mm Chrome steel ball bearing	4 x 5mm Chrome steel ball bearing
100% FSD Fine	0.1g iron powder	0.25g iron powder	0.5g iron powder

Using the table below select the sensitivity scale for the ferrous metal sensor from the menu. These set the Coarse and Fine scales according to the size/quantity of the debris.

Note: The factory default sensitivity is always set to Small. Note also that, once the sensor head is installed on the equipment, there is the option of customizing the settings to suit the application (see Section 4) in which case these sensitivity settings no longer apply.

Please see section 2.7 for details of the debris strip available as an accessory to assist this process.

Details of the default sensor configuration can be found in Appendix B.

3.5 Debris bench test

WearDetect contains a dielectric sensor used to detect significant (>10%) water contamination within the oil or to report a “no-oil” condition.

Gill recommend setting up the sensor prior to use by observing the following

3.6 Bench set up

Note; Handle the sensor head by the cable only to avoid miscalculations through handling the sensor head body directly

Note; Use a grounded metallic beaker containing the same oil (clean) that will be used in the equipment

- ▶ Navigate to the oil tab within the software - Sensor/Configure/Water Contamination
 - ▶ Fully immerse the sensor element into the fresh oil taking care to keep hands away from the sensing element
 - ▶ Press the "Set Clean Oil Reference" button to set the level. (Normalised at 1000)
- Repeat the above steps once the sensor is installed in the equipment
- ▶ Wait 3 seconds and take note of the value
 - ▶ Dip in the oil twice more recording the values
 - ▶ Average the three recorded values and enter into the "No Oil Threshold" field and press the set button
 - ▶ Mix a minimum 10% water-oil sample, dip the sensor three times taking three readings
 - ▶ Average the readings and enter the value into the "Water Contamination Threshold" field
 - ▶ Ensure the reported value is shown in red when the sensor is in the contaminated mix, else lower the threshold value to 1 below reported value

4. Install WearDetect

WearDetect consists of the following two parts:

- Sensor head & electronics
- Sensor thread adaptor (Sold Separately)

The sensor should always be used with a purpose designed adaptor supplied by Gill.

4.1 Sensor Location

All models in the range must be installed within the lubricating circuit of the equipment to be monitored. The sensor head can either be installed as a sump plug replacement or within piped oil circuit, often used as a filter bypass. In this instance, please see separate instruction regarding this installation type from Gill.

When installing the sensor head, please observe the following guidance for ferrous material monitoring

- ▶ Install within the flow of oil when possible
- ▶ Install upstream of any particle filters to maximise debris collection
- ▶ Install at the bottom of an oil pump or reservoir to capture settled particles

When installing the sensor head for oil contamination applications, please observe the following guidance

- ▶ Install at the bottom of the sump for non-miscible oils
- ▶ Install at any point providing the oil sensing region of the sensor remains in permanent contact with the oil.

When installing the sensor head for oil loss applications, please observe the following guidance

- ▶ Install in any orientation (Oil loss status is reported when oil ceases to be in contact with the sensor)

Please note oil/water sensing is not available when used with an NPT thread adaptor.

WearDetect

Oil Debris Sensor

4.2 Sensor Head

Weardetect contains multiple sensors within one sensor head enclosure as shown below

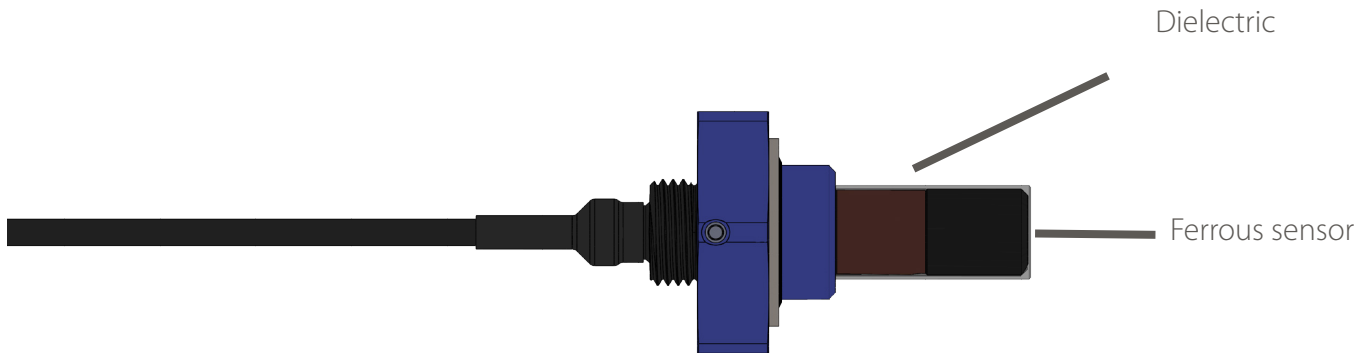

To allow the product to fit a wide range of equipment types, a separately supplied thread adaptor is needed for all installations

Thread Size	A	B	C
M20 x 1.5 to M24 X 1.5	37.05 mm	12.7 mm	8 mm
1/2" BSP	36.55 mm	13.2 mm	7.5 mm
3/4" X 16 UNF	36.55 mm	13.2 mm	7.5 mm
1/2" BSPP	32.46 mm	17.29 mm	13.56 mm
1/2" NPT	32.46 mm	17.29 mm	13.56 mm
3/4" NPT	32.76 mm	16.99 mm	13.86 mm
1" NPT	36.24 mm	13.51 mm	17.34 mm
1 1/4" NPT	36.85 mm	12.9 mm	17.95 mm
1 1/2" NPT	42.05 mm	12.47 mm	18.38 mm

* NPT do not include bonded seal

WearDetect

Oil Debris Sensor

The following illustration show how these two are used together;



To install the sensor head into the equipment having previously obtained both the sensor and the correct thread adaptor from Gill, the following steps should be observed;

- ▶ Apply threadlock (Loctite 270 or similar) to the grub screws for high vibration applications where a permanent connection is preferred
- ▶ Fit at least one of the three grub screws into the adaptor without tightening them home
- ▶ Fit the sealing washer to the adaptor or use a suitable thread sealant for NPT adaptors
- ▶ Fit the thread adaptor to the equipment tightening by hand
- ▶ Fully tighten to 50Nm using the correct spanner (see Gill Adaptor instructions)
- ▶ Fit the sensor into the adaptor, pushing passed the o-ring seals fitted to the sensor
- ▶ Once the rear surfaces of the sensor head and adaptor are level with the sensor fully inserted tighten the grub screw using a 2mm hex key to a torque of 1Nm.
- ▶ Restrain the sensor cable safely to avoid future damage to it.

Alternative Installation

It is also acceptable to install the sensor head to the adaptor prior to installing the assembly into the equipment. With this installation type, take care not to twist the sensor cable. Please ensure the equipment the sensor is installed into is grounded.

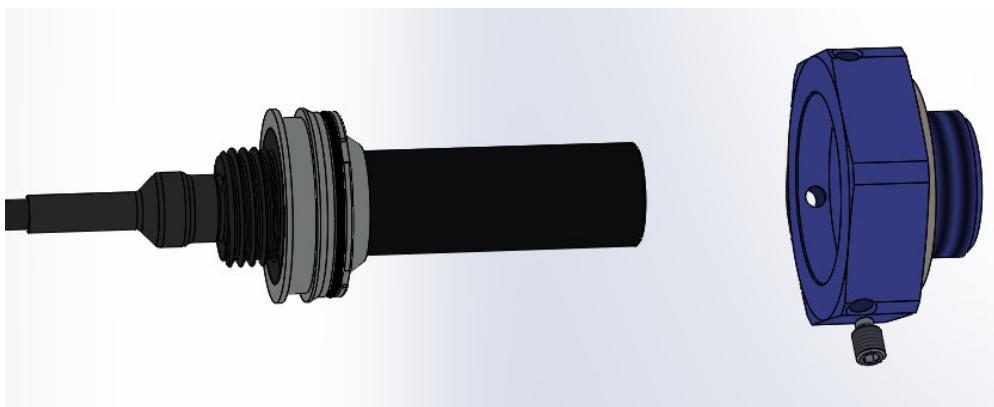

See Weardetect Quick Start Guide - Thread adaptors" for more details

WearDetect

Oil Debris Sensor

4.3 Sensor Electronics

Gill recommend positioning the sensor electronics in a position where vibration is minimised and, with regard to the display model, where the display is visible.

Sensor with display

Two diameter 6.4mm mounting holes are provided for fixing the sensor electronics to a fixed surface. The mounting holes are accessed by removal of the lid. The fixings (not provided) shall be suitable for supporting the weight of the enclosure. The following figure shows the mounting dimensions:

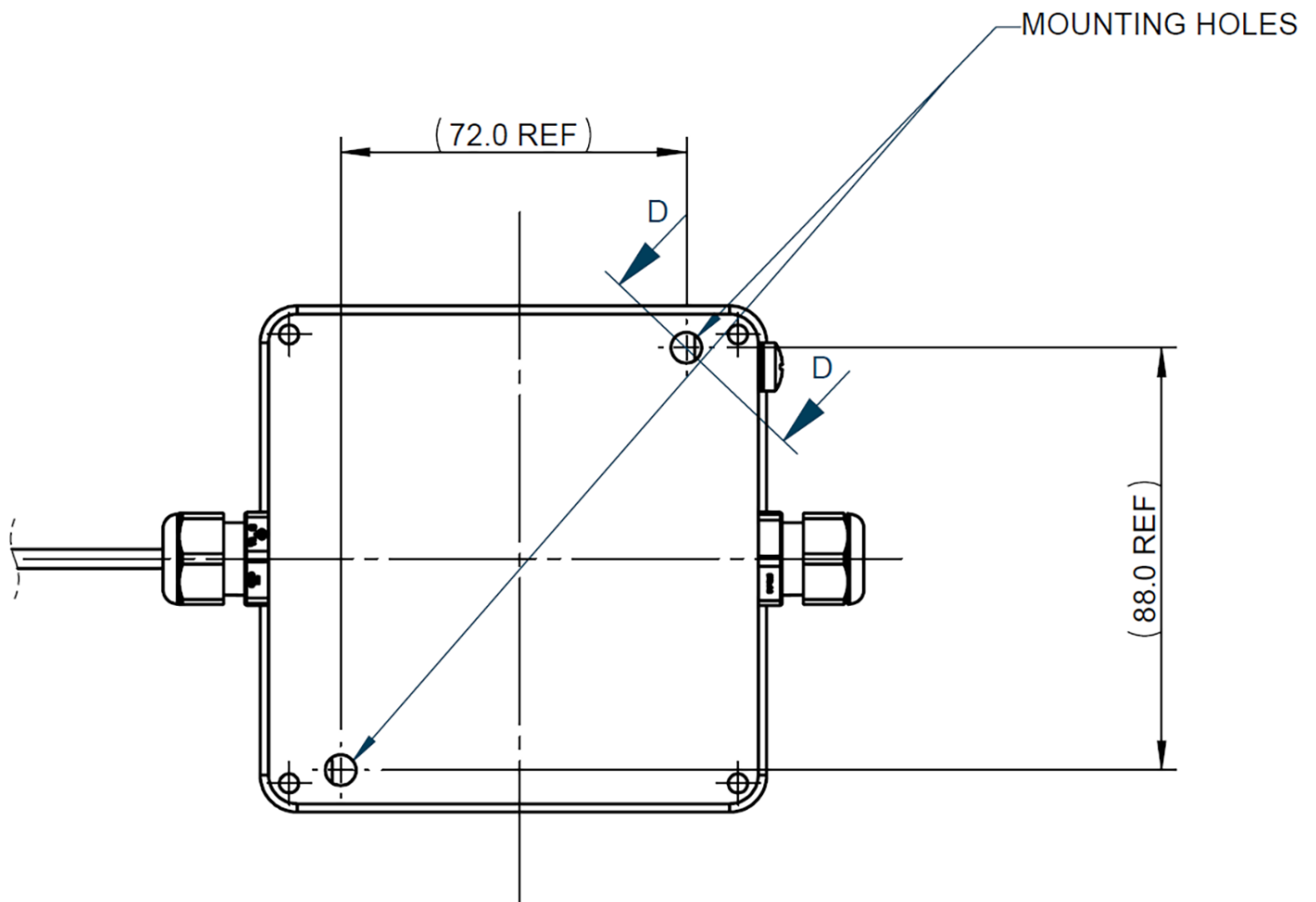

Sensor without display

Two 4.2mm diameter mounting slots are provided for fixing the electronics enclosure to a fixed surface. The fixings must be suitable for supporting the weight of the enclosure. The following figure shows the mounting dimensions:

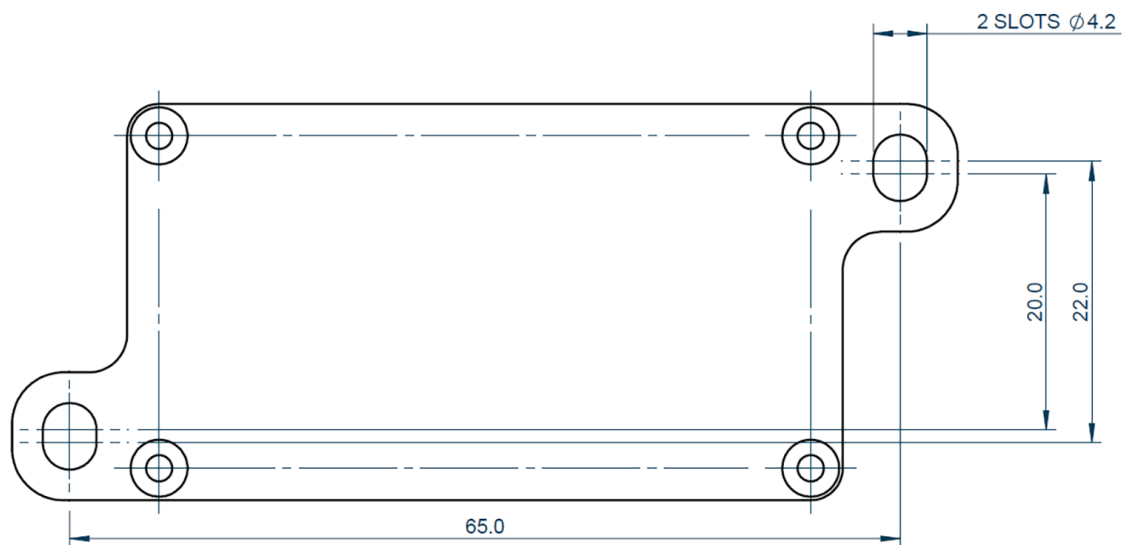

4.4 Sensor Cabling

Gill recommends a maximum of three sensor head cable turns to avoid cable coiling prior to installation. Sensor to electronics cabling may be shortened and re-attached only on models with display using the supplied bootlace ferrules for re-connection. Cable length must not go above 3m to preserve signal reliability.

Cable strain relief has been provided where cables enter both the sensor head and electronics enclosures. Please take care not to stress the cables at the cable entries, observing a minimum bend radius of 20mm for all cables.

Note; On units with display electronics cable glands are suited to cables between 2 – 6mm diameter. When installing this unit, please ensure glands are fully tightened to maintain the strain relief and ingress protection for the unit.

WearDetect

Oil Debris Sensor

Cable Protection: Sensors with display models

An optional conduit kit (Gill part No. 4212-10-051-X) is offered for additional cable protection for the Sensor with display models. For installation, follow the guidance below:

- ▶ Fit conduit before sensor is fitted to the thread adaptor
- ▶ Remove your Oil Debris Sensor from the Sensor with display electronics enclosure, disconnecting the wiring from the termination block.
- ▶ Remove the M16 cable gland from the sensor by unscrewing the M16 back nut.
- ▶ Install the female adaptor onto the back of the sensor head, using an appropriate thread sealer to maintain the ingress protection of the enclosure.
- ▶ Cut the conduit tube to the required length, feed the sensor head cable through the conduit tube and clip into the back of the female adaptor by firmly pushing the tube into the aperture.
- ▶ Feed the cable through the male adaptor and clip into the back of the adaptor by firmly pushing the tube into the aperture.
- ▶ Install the sensor into the gearbox, engine or pump housing ensuring that the sealing washer is used.
- ▶ Fit the male adaptor into the enclosure by securely fastening the back nut ensuring that the sealing washer is used.

4.5 Connections (with / without display)

Connect the sensor according to the following;

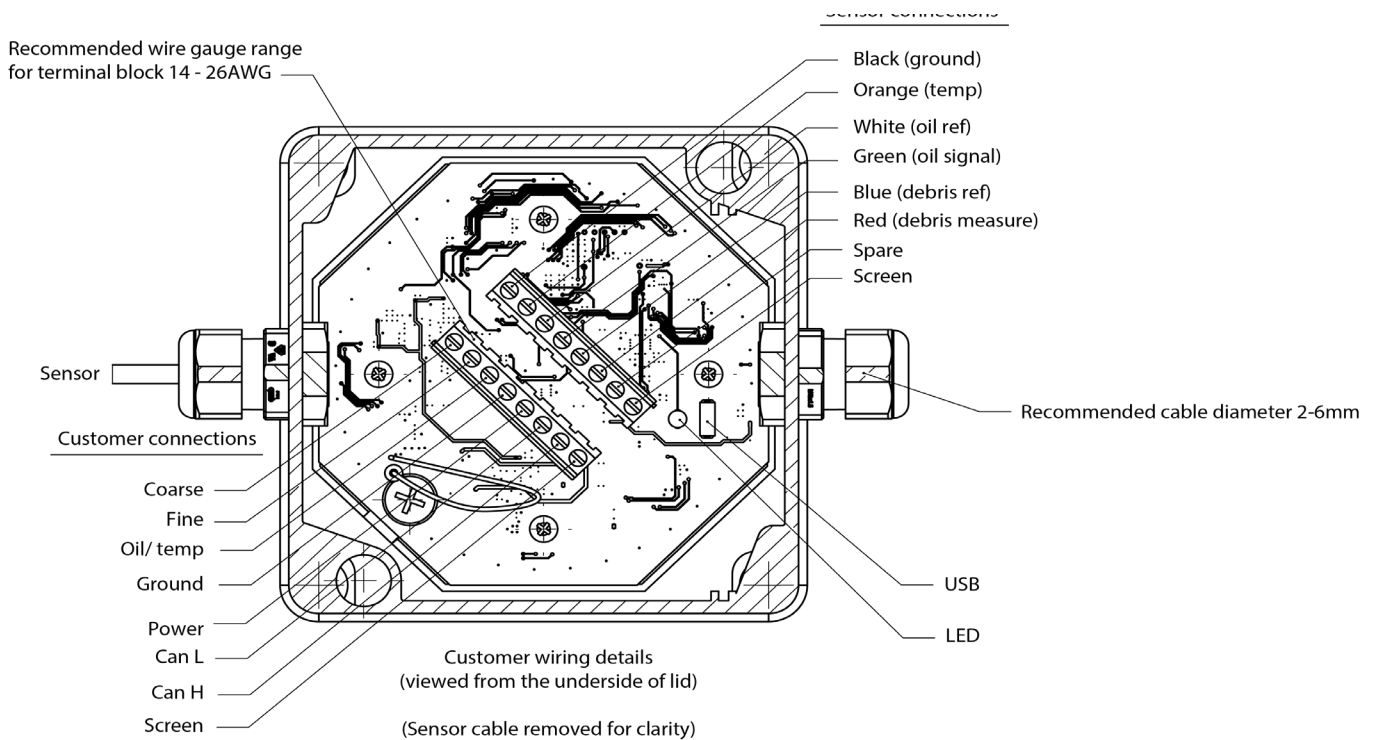

Connections - Analogue 4-20mA & 0-10V

	Wire Colour	Designation
	White	Fine
	Green	Coarse
	Orange	Oil/Temp
	Black	Power Gnd (V-)
	Red	Power (V+)
	Blue	(Not Connected)
	Clear	Screen

Connections - Digital CAN J1939

	Wire Colour	Designation
	White	Can H
	Blue	Can L
	Orange	(Not Connected)
	Green	(Not Connected)
	Red	Power (V+)
	Black	Power Gnd (V-)
	Clear	Screen

Connections - MODBUS RTU

	Wire Colour	Designation
	White	Signal ground
	Blue	(Not Connected)
	Orange	Data - (B)
	Green	Data + (A)
	Red	Power (V+)
	Black	Power Gnd (V-)
	Clear	Screen

4.6 Sensor Inflow Installation

For detailed instruction please consult the Weardetect Inflow accessory instructions found at www.gillsc.com/support

The optional Inflow accessory allows the installation of the sensor into an oil bypass circuit. The following two kits fit standard BSP pipe fittings and contain the Inflow adaptor, isolation valves and brackets.

These kits are;

- Inflow Oil Debris Kit 1"
- Inflow Oil Debris Kit 1.5"

Use of these kits requires the sensor to be fitted with the Gill M20 x 1.5 sensor head adaptor, part code 4212-PK-502

The following illustrates the sensors and inflow adaptor kit.

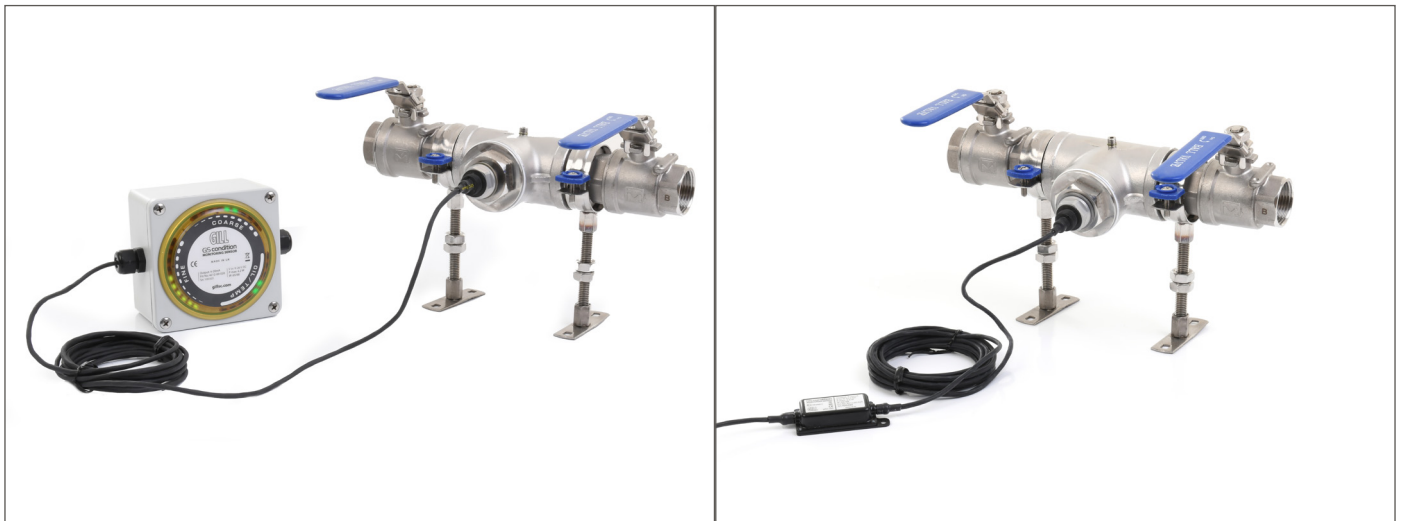

WearDetect

Oil Debris Sensor

Sensor Inflow Adaptor

In addition, Gill can offer the sensor mount separately where isolation valves and associated hardware is not needed. This is a 1.5" diameter BSP fitting and allows connection to smaller pipe sizes with additional pipe size reducers (not supplied).

Use of the Inflow Adaptor requires the sensor to be fitted with the Gill M20 x 1.5 sensor head adaptor, part code 4212-PK-502.



For further guidance on installing the sensor within a piped oil system using the Inflow models, please refer to the WearDetect Inflow Adaptor Quick Start Guide.

Note: The installation of the inflow kit should be bonded to earth. Refer to Appendix C for more details.

5. Use WearDetect

5.1 Configuring the sensor

The Sensor can be configured using the WearDetect Software. The configuration functions are outlined below. To access the configuration:

- ▶ Select the Sensor
- ▶ Configure option from the top pull down menu.

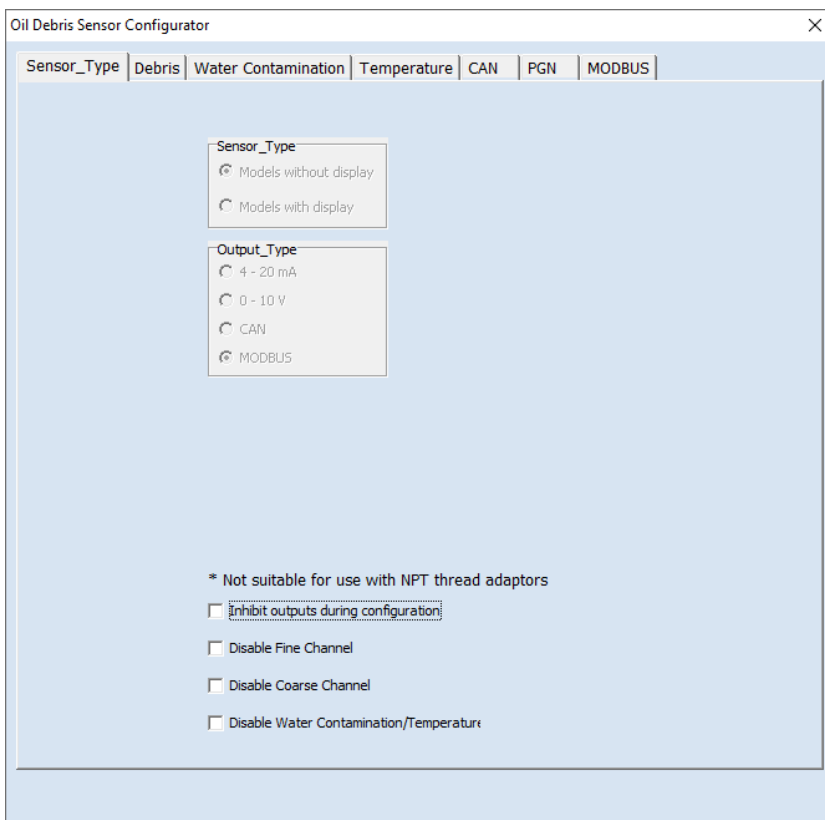

Note that on the display model of the product, the green LEDs will turn to blue whilst configuring the sensor.

Sensor Type

The sensor type is factory configured and is displayed for reference purposes only. The button references either the Sensor with display models (4212i) or the Sensor without display models (4212).

Sensor Output

The sensor output type is factory configured and is displayed for reference purposes only. The button

references either 4-20mA, 0-10V, CAN or Modbus output types.

Note: The home screen now reflects the options selected. Unused features shall be disabled in this window.

Water Contamination /Temperature Channel

▶ Select the required third channel output option by clicking the "Water Contamination" or "Temperature" button. On setting the 3rd channel status, the configuration tabs are automatically adjusted to display the selected channel options.

▶ The 3rd channel status is set to Water Contamination by default.

Note: If you have an NPT thread fitting, please change the default and select temperature.

Inhibit Outputs during Configuration

Note. These options are not required for the Modbus version.

▶ Select the "inhibit outputs during configuration" to fix the analogue outputs to a known state. This may be used to disable external alarm conditions during configuration and maintenance of the Oil Debris Sensor i.e. when an external PLC controller alarm status may be triggered while setting the Full Scale Deflection (FSD) level. The analogue output levels can be set by the user within the Analog Output tab>Inhibit level. On disabling the Inhibit outputs during configuration feature, the inhibit level is disabled from the Analog Output tab.

▶ The "inhibit outputs during configuration" option is switched on by default and is set to 0.5 V for the voltage output versions and 2 mA for the 4-20 mA output versions.

Disable Fine Channel

▶ Select the "disable fine channel" option to make the fine channel inoperable. On disabling the fine channel option, setting of the fine channel is disabled from the Debris tab.

Note: the home screen now reflects the options selected. Unused features shall be disabled in this window.

▶ The "disable fine channel" option is switched off by default, meaning the fine channel is enabled.

Disable Coarse Channel

▶ Select the "disable coarse channel" option to make the coarse channel inoperable. On disabling the coarse channel option, setting of the coarse channel is disabled from the Debris tab.

Note: the home screen now reflects the options selected. Unused features shall be disabled in this window.

- ▶ The “*disable coarse channel*” option is switched off by default, meaning the coarse channel is enabled.

Disable Water Contamination/Temperature Channel

- ▶ Select the “*disable fine channel*” option to make the Water Contamination/temperature channel inoperable.

- ▶ The “*disable Water Contamination/Temperature channel*” option is switched off by default, meaning the channel is enabled in it's out of the box condition.

Zero/Tare

The “*zero/tare*” function must be used if during installation the sensor develops an offset due to surrounding metalwork. This shall become evident if the sensor output is greater than the zero level specified by the user (>0%) without debris present following installation into the gearbox. This function is accessed under “Debris” tab.

It is recommended that the zero/tare function is used at the start and end of every configuration and with all installations using the NPT fitting adaptors.

- ▶ On this screen you will see three buttons labelled **Zero / Full Scale Coarse / Full Scale Fine**.
- ▶ Press the “Zero” button to reset the sensor head.

Note: the sensor is now configured with default settings. If further adjustment is required to fine tune the sensor to a particular application or if the default settings are not suitable, please refer to section 5.

Note: On completion of configuration, remove the USB cable and power down the sensor and and re-assemble the lid ensuring the sealing gasket is correctly located and the screws are fully tightened to 0.5 or 4 Nm (+/- 10%) for Inline or Display models respectively..

Temperature

The temperature sensor measures the oil temperature at the sensor head. Either a high / low alarm can be set or continuous temperature can be reported.

Input the desired temperature values into the dialogue box and press the set button to write the value to the

High Temperature Alarm(C)

Low Temperature Alarm(C)

Temperature alarm settings

sensor.

High Temperature(C)

Low Temperature(C)

Continuous temperature min / max settings

See below for settings for high / low alarm.

For the temperature alarm, set the high and low settings between those shown below

For a continuous temperature feed, set the range of temperature measurement as shown below.

5.2 Advanced Settings & Adjustments

Full Scale Fine

The "full scale fine" operation will gauge the output of the sensor to the desired level with the maximum amount of fine debris applied to the sensor (100% Full Scale Deflection).

- ▶ Add some fine debris to the sensor head (again this should represent what you would constitute to a 100% failure).
- ▶ A fine value will now be displayed in the window.

WearDetect

Oil Debris Sensor

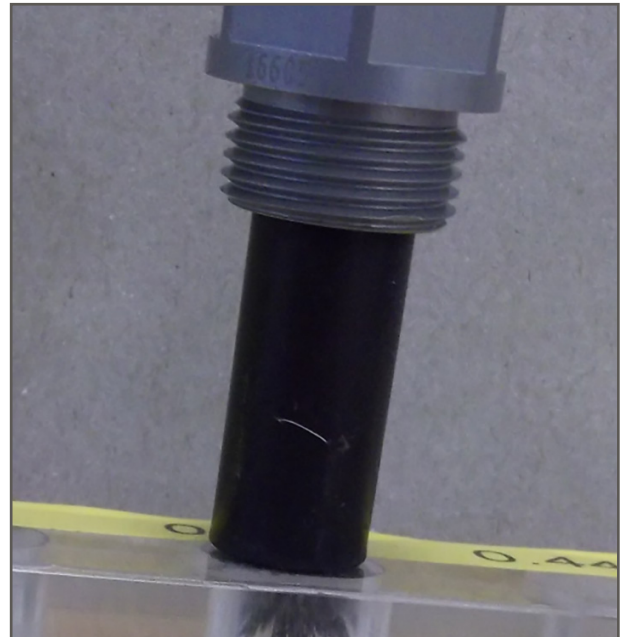
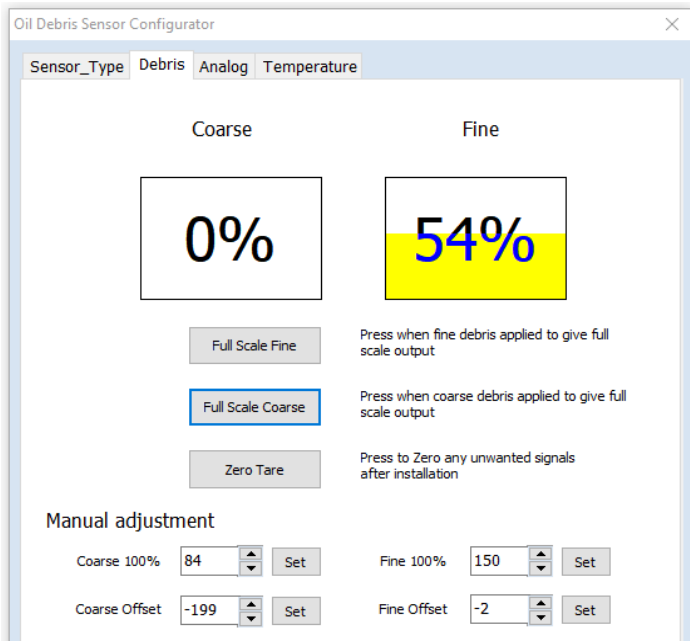

Note: The numbers in the boxes displayed above are internal sensor counts, not percentages. For average chip detection Gill Recommend the Coarse 100% be set to 250. Fine 100% can be set to 750 for maximum fine channel range. for customers trending the output.

▶ Press the "Full Scale Fine" Button and this will set this quantity of debris as 100%.

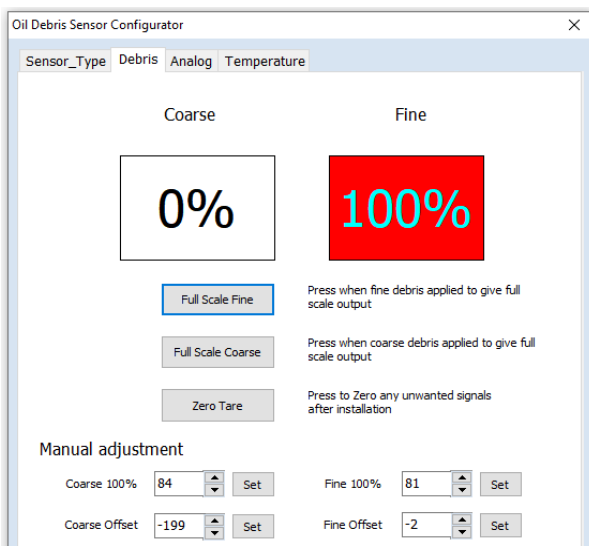

The sensor head is now calibrated and ready to fit to your equipment.

WearDetect

Oil Debris Sensor

Full Scale Coarse

The "full scale coarse" operation will gauge the output of the sensor to the desired level with the maximum amount of coarse debris applied to the sensor (100% Full Scale Deflection).

Add some coarse debris to the sensor head (This should represent what you would constitute to a 100% failure). For this demonstration five 2mm balls were used.

Note: see Section 9.1 for the saturation point of coarse debris.

- ▶ The debris strip may also be used as reference.
- ▶ A coarse value will now be displayed in the window.

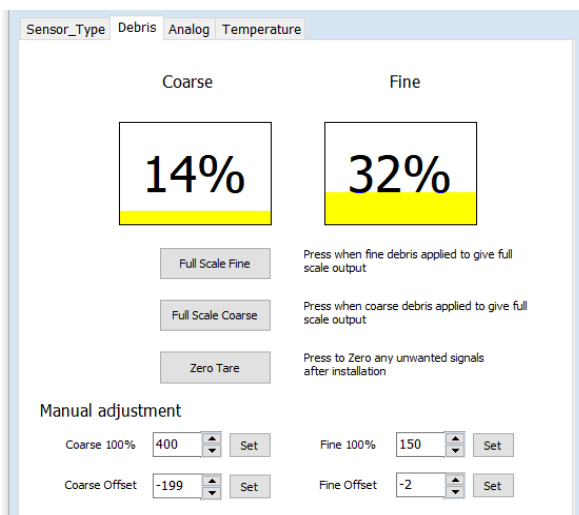

- ▶ Press the "Full Scale Coarse" Button and this will set this quantity of debris as 100%.

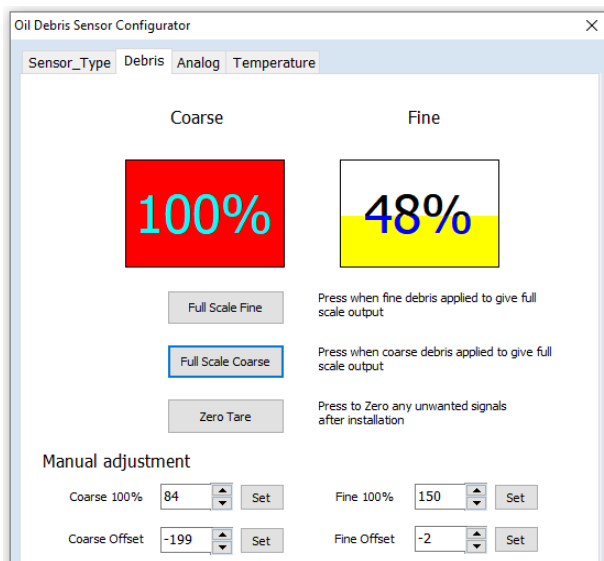

5.3 Manual Adjustment

The “*manual adjustment*” function allows adjustments to the zero and full scale deflection of the fine and coarse channels. The up/down arrows can be used to bias the zero and full scale within the graphics window.

When the desired values are selected press the set button to write the value to the sensor.

Please note:

- Do not enter negative values for coarse and fine 100% as these would make the sensor operate in reverse, i.e. the less debris collected the greater the percentage displayed.
- If the value is too great then the setting is too insensitive and the percentage level displayed will be zero. Conversely, if the value is too low then the setting is too sensitive and the percentage level will be 100%, even if no debris is present.
- It is advisable to set both channels to 250 in the first instance.

Note: The numbers in the boxes displayed above are internal sensor counts, not percentages. For average chip detection Gill Recommend the Coarse 100% be set to 250. Fine 100% can be set to 750 for maximum fine channel range. for customers trending the output.

5.4 Oil Calibration

General Handling Practices

When performing bench top calibration of the sensor it is important to follow the handling practices below, particularly for the calibration of the water contamination channel. Incorrect handling of the sensor can result in inaccuracies of the measurement, and calculated thresholds.

When handling the sensor to record measurements, the sensor should be held by the cable by the probe head, or by the heat shrink. This prevents introducing errors during water contamination measurements.

Bench top Calibration of the water contamination must be performed in a metallic beaker that can be connected to earth (or the shield connection of the sensor). Use of ungrounded or non-conductive containers prevents an accurate reading of the oil.

For inflow kit customers, this can be achieved by grounding the kit to earth, or to the shield connection of the sensor.

This grounding only applies to bench-top calibration. Final installations should follow grounding procedures outlined in Appendix C.

Note: Oil calibration should be performed using clean oil and shall be the same type that will be used in the install.

WearDetect

Oil Debris Sensor

Note: Oil dielectric measurement is not available where the sensor to be used has an NPT thread fitting.

WearDetect measures the dielectric property of the liquid surrounding the sensor element. This is used to provide information about dielectric changes such as a no-oil condition (air) or water in oil condition.

When a Water Contamination alarm threshold is reached, the sensor output is triggered to full scale. Normal Water Contamination remains at zero. When Water Contamination continuous is selected the sensor output will report a normalised value scaled between minimum and maximum values set in the configurator. Therefore it is important to determine and set appropriate thresholds for the oil in use. This can be achieved following the process outlined.

▶ Select the Sensor pull down menu and then the Configure setting.

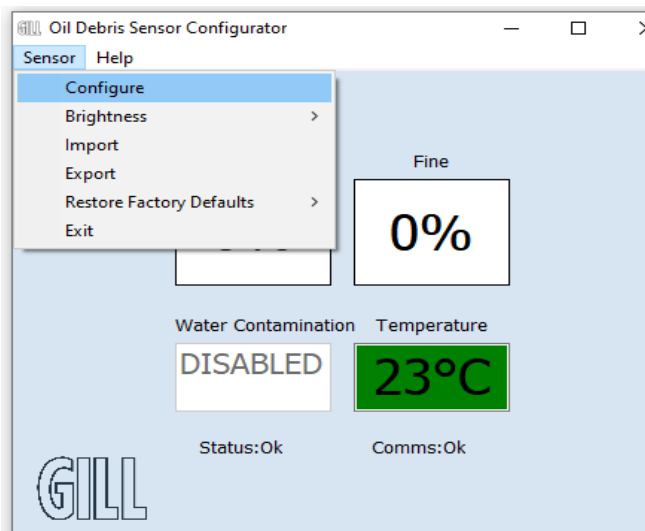

Note: The "Water Contamination" measurement is only a bulk indication, and the sensor will not accurately detect water content below 10% by volume (v/v).

▶ Select the oil tab from this new window.

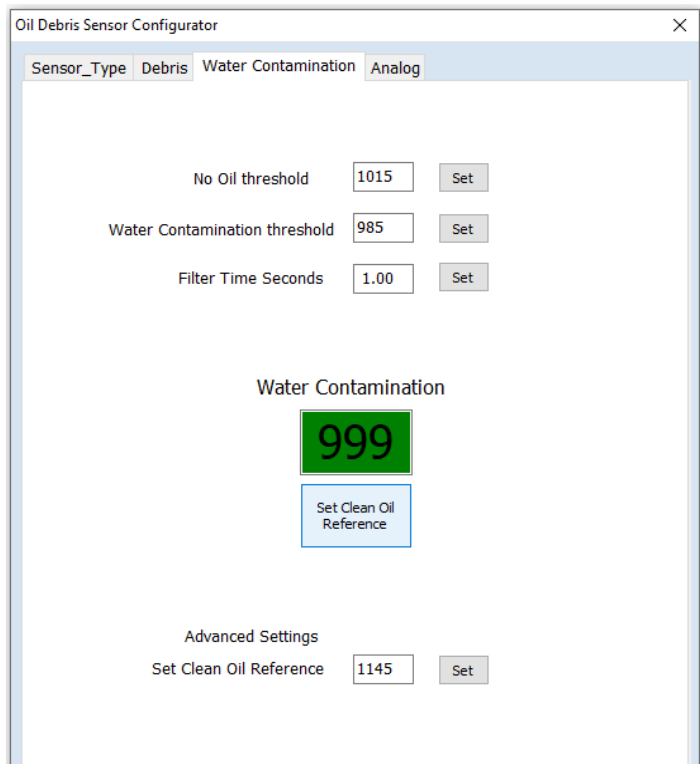

▶ Fully immerse the sensor element in the selected reference oil (fresh oil) to set the Water Contamination reference value. The value should be normalised to 1000 once set.

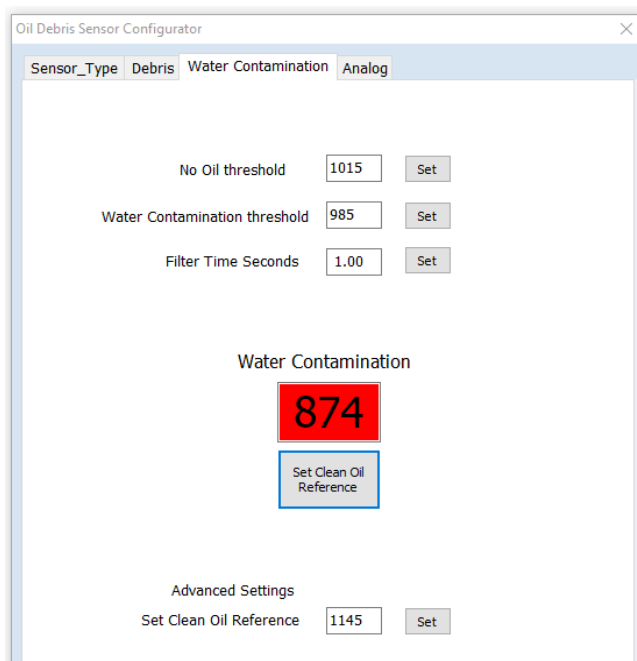

WearDetect

Oil Debris Sensor

▶ Press the “Set Water Contamination Reference” button and this will return the value to 1000.

Note: This Clean Oil Reference is only valid for the bench-top calibration process, and will need to be re-calibrated once the sensor is installed.

▶ Now remove the sensor head from the oil, wait 3 seconds, and take note of this value. Re-immers the sensor in the oil, and repeat this process twice more. Average the values to determine the no-oil threshold.

Water Contamination

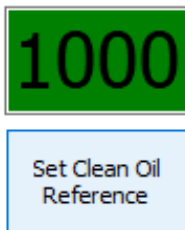

▶ Input this value into the “No Oil Threshold” field and press the set button.

▶ Finally, repeat the process to ensure the alarm is activated on removal. If the Water Contamination is not shown in red, lower the threshold value to 1 count below the displayed Water Contamination value.

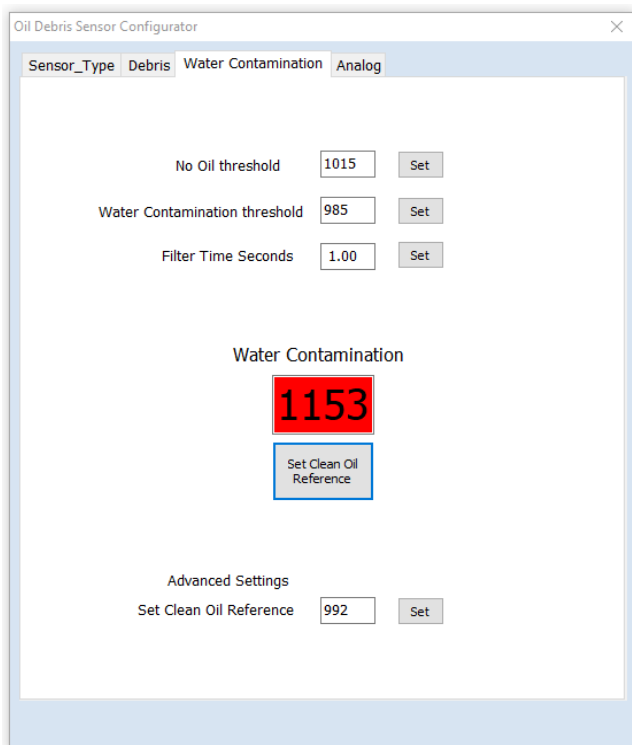

WearDetect

Oil Debris Sensor

- ▶ To migrate the risk of false alarms, it is advisable to establish the threshold at the highest level allowable.
- ▶ Thoroughly mix at least 10% by volume of water into the oil sample. Fully immerse the sensor element into the mix and record the displayed Water Contamination value. Remove the probe, remix the solution, and re-immerses the sensor. Record the displayed value and repeat this process. Average the 3 readings, type the value into the Water Contamination Threshold field and press set.

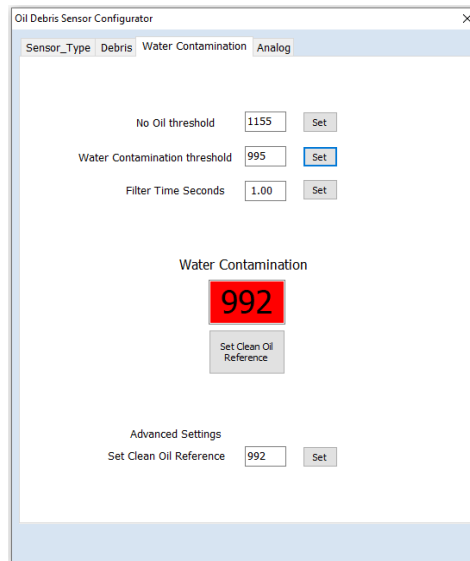
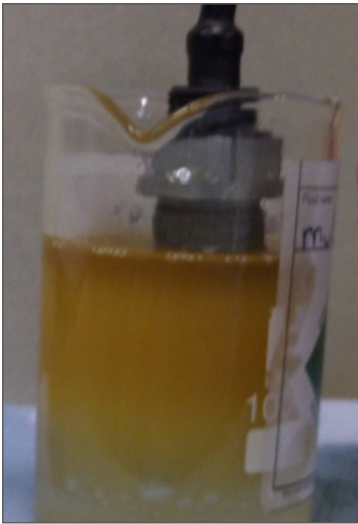

Note: Ensure correct handling practises are adhered to according to this manual Images of sensor in glass container are for visual reference only.

- ▶ Finally, repeat the process to ensure the alarm is activated. If the Water Contamination is not shown in red, increase the threshold value by 1 count above the displayed Water Contamination value.

NOTE: manually setting the threshold above the Water Contamination value displayed for 10% v/v increases the potential of false alarms.

- ▶ The sensor head is now calibrated and ready to fit to your equipment.

Set Clean Oil Reference

Fully immerse the sensor element in the selected reference oil (fresh oil) to set the clean oil reference value. The Water Contamination window displays the reference value in real time. The value should be normalised to 1000 once set.

The raw value for "set clean oil reference" is displayed in the set clean oil reference dialogue box. This feature is used for diagnostic used - contact support for further details, if required.

Note: when the lower or upper alarm thresholds are reached the window changes status from green to red.

For bench-top calibrations, follow correct handling practises outlined in section 5.4

This process should be performed following successful installation of the probe into the equipment, to remove disturbances to the reading from surrounding metalwork.

No Oil Threshold

The “*No oil threshold*” is used to set the no-oil condition of the sensor.

To set the no oil threshold, remove the sensor element from the oil and note the new Water Contamination reference number with the sensor element positioned in free air. Enter the desired value into the “no oil threshold” dialogue box and press the set button to apply the new value.

Note: the value should be set between the reference oil (1000) and the reference air value (>1000).

Water Contamination Threshold

The “*water contamination threshold*” is used to set the end of life oil or water in oil condition of the sensor.

To set the water contamination threshold, place the sensor element in the end of life oil sample or water in oil sample and note the new Water Contamination reference number. Enter the desired value into the water contamination threshold dialogue box and press the set button to apply the new value.

Filter Time (seconds)

The “*filter time*” function is normally set to a 1 second sample period. The sample period may be extended to prevent false alarms in splash systems where the sensor element is not fully in contact with the oil.

6. Sensor Head

6.1 Cleaning

The Oil Debris Sensor reports the amount of ferrous material attached to the sensor in real time. It is recommended that the sensor is investigated once the full scale output is reached.

To carry out investigation: Unscrew the complete thread adaptor and sensor assembly from the equipment using the correct spanner. The user can decide whether to remove the debris at this time or to re-install and increase the full scale alarm level.

Note: To investigate debris build-up DO NOT remove the sensor probe from the thread adaptor while it is installed in the equipment: The sensor probe will have attracted debris which will damage the internal O-rings if removed at this stage. However, the Grub screw can be slightly loosened to allow the sensor to freely spin within the adaptor to prevent cable from coiling. The Grub screw will need heat applied to overcome the Threadlock compound and avoid being damaged.

Note: Avoid overheating sensor and cable.

It is recommended that the sensor is cleaned with a non-abrasive cloth prior to installation, removing any traces of used oil or metallic debris.

It is not necessary to remove the sensor probe from the adaptor for routine servicing, but is possible only when necessary by loosening the grub screw(s).

Note: Abrasive cleaners or solvents must not be used to clean the Oil Debris Sensor

6.2 Servicing

▶ There are no serviceable parts on your Oil Debris Sensor; however it is recommended that the following periodic checks are made:

- ▶ Periodically check your Oil Debris Sensor for oil leaks. If any oil leaks are observed, refer to the sealing notes in this manual and securely tighten the sensor into the gearbox or engine housing.
- ▶ Periodically check the tightness of the grub screws holding the sensor head to the thread adaptor.
- ▶ It is recommended that your Oil Debris Sensor zero/span/oil reference is checked periodically to ensure that your sensor is fully functioning using the Gill Oil Debris Monitoring Sensor configurator.
- ▶ Lid screws are fully fastened to prevent ingress into the electronics housing.
- ▶ Cable glands (Sensor with display models only) are fully fastened prevent ingress into the electronics housing.

Note: To remove the assembly DO NOT remove the sensor probe from the thread adaptor while it is installed in the equipment: The sensor probe will have attracted debris which will damage the internal O-rings if removed at this stage.

WearDetect

Oil Debris Sensor

However, the Grub screw can be slightly loosened to allow the sensor to freely spin within the adapter to prevent the cable from coiling. The Grub screw will need heat applied to overcome the Threadlock compound and avoid being damaged. Unscrew the complete thread adaptor and sensor assembly from the equipment using the correct spanner. Clean and remove the sensor probe for servicing in a suitable workshop.

Note: Avoid overheating sensor and cable.

Corrosion

All of the Oil Debris Sensor components are treated for protection against corrosion.

Sealing

The thread adaptor is sealed to the oil enclosure with either a supplied hydrogenated nitrile (HNBR) bonded sealing washer (non-NPT), or a suitable sealing compound (NPT only). It is recommended that the seal is periodically checked for leaks and a new washer or sealant fitted if necessary.

O-Rings are used to seal the sensor head to the thread fitting adaptor. Under normal use the o-rings should not become damaged however, Gill recommend observing the o-ring seal periodically and replacing if necessary.

Adaptor	Description	Adaptor O-Rings	Quality Required	Adaptor Bonded Seals	Quantity Required
4212-PK-504	ODS Thread Adaptor M22x1.5	O-Ring 14 x 1 HNBR	1	Bonded Seal Self Centralising FKN-Metric 22	1
4212-PK-507	ODS Thread Adaptor M24x2.0	O-Ring 14 x 1 HNBR	1	Bonded Seal Self Centralising FKN-Metric 24	1
4212-PK-552	ODS Thread Adaptor 3/4"UNF x 16	O-Ring 14 x 1 HNBR	1	Bonded Seal Self Centralising FKN-BSP 1/2"	1
4212-PK-533	ODS Thread Adaptor 1/2"BSP x 14	O-Ring 14 x 1 HNBR	1	Bonded Seal Self Centralising FKN-BSP 5/8"	1
4212-PK-502	ODS Thread Adaptor M20x1.5	O-Ring 14 x 1 HNBR	1	Bonded Seal Self Centralising FKN-Metric 22	1
4212-PK-571	ODS Thread Adaptor 1/2"NPT x 14	O-Ring 14 x 1 HNBR	1	Thread Sealant	As Required
4212-PK-573	ODS Thread Adaptor 3/4"NPT x 14	O-Ring 14 x 1 HNBR	1	Thread Sealant	As Required
4212-PK-575	ODS Thread Adaptor 1"NPT x 11.5	O-Ring 14 x 1 HNBR	1	Thread Sealant	As Required
4212-PK-576	ODS Thread Adaptor 1,1/4"NPT x 11.5	O-Ring 14 x 1 HNBR	1	Thread Sealant	As Required
4212-PK-577	ODS Thread Adaptor 1,1/2"NPT x 11.5	O-Ring 14 x 1 HNBR	1	Thread Sealant	As Required

Sensor Head	Description	Sensor O-Ring	Quantity Required
4212-PK-145,146,147,148,149,150, 151	Sensor Head (All Variants)	O-Ring 23 x 1 HNBR	1

Frequently Asked Questions

Q. I can't access the Water Contamination/temperature channel

A. The Water Contamination/temperature channel is disabled from the sensor type menu.

Q. I can't set the inhibit level;

A. The inhibit outputs during configuration function is disabled from the sensor type menu.

Q. The sensor output is greater than the zero level specified by the user (>0%) without debris present.

A. Check there is no debris present on the sensor and repeat the zero / tare step with the sensor installed in the application. Note: adjacent metalwork can cause a sensor offset and needs to be zero'd out after installation.

Q. The status LED's do not light up

A. Turn up the brightness level.

Q. The water contamination channel is not showing "1000" when the sensor is installed into the equipment with clean oil.

A1. Check that the sensor has been fully inserted into the thread adapter body, and that an NPT thread adapter is not in use.

A2. Ensure that the "Set Clean Oil Reference" operation has been performed following successful installation of the sensor. See section 4.4.2 for further details.

Q. Returning a Faulty Sensor

A. Should a fault arise during the use of your Oil Debris Sensor which is within the warranty period, or if you require a repair to your sensor please contact Gill Sensors & Controls for a Return Material Authorization number (RMA). Please ensure any return units are cleaned prior to shipment.

6.3 Software

Please ensure you are using the latest version of the software, available from the Gill website. This allows all the latest features to be available to your sensor.

Software can be downloaded from www.gillsc.com/support

6.4 Sensor De-commissioning

Uninstall the Oil Debris Sensor Configurator App

Launch the Oil Debris Sensor configurator uninstall software application from your program file location selected during installation. Alternatively, open Control Panel>Programs and Features and select the Oil Debris Sensor Configurator from the list and select the Uninstall option to remove your Oil Debris Sensor configurator software from your PC.

Appendix A

Sensor outputs

Analogue Output		
Setting	Description	Channel
Error level	Output level when the sensor is in a failure state.	All three channels
Zero level	Output level for 0% debris, Water Contamination Threshold met (Alarm / Continuous), or High Temperature Threshold met (Alarm / Continuous).	
Full scale level	Output level for 100% debris, No Oil Threshold met (Alarm / Continuous), or Low Temperature Threshold met (Alarm / Continuous).	
Inhibit level	Output level for 100% debris, No Oil Threshold met (Alarm / Continuous), or Low Temperature Threshold met (Alarm / Continuous).	

CAN Output	
Description	Setting
Function instance	Factory setting 0000
ECU instance	
Industry group	
Vehicle system instance	
Vehicle system	
Manufacture code	Factory setting 07FF
Function	Factory setting 07FF
Identity number	Factory setting 0000
Name	User configured
Priority	Factory setting 0006
Data page	Factory setting 0001
PDU format	Factory setting 00FF
PDU specific	Factory setting 0000

Note; Further Information can be found in the J1939 Standard.

WearDetect

Oil Debris Sensor

Modbus output settings

The default connection settings for the sensor are 19200 Baud, 8 Data Bits, Even Parity, 1 Stop Bit, and Slave ID 1. Communication requires a minimum of 1000 ms delay between transactions to return the contents of all registers.

For all 16-bit/32-bit registers, the order of the data bytes is a High Byte/Word First.

Connection Notes

Some equipment may use reversed labels to those found on the Oil Debris Sensor (A+/B-). When making connections between equipment, if the sensor will not communicate, reverse the connections at one end.

After powering up the Oil Debris Sensor, wait 10 seconds before requesting any measurements.

Terminating resistors may be required on the RS-485 data lines. This can be achieved with the use of an external resistor (matching the Characteristic Impedance of the network cable - typically 120 Ω).

Register map	Data type	Description (units)	Range
40001	16-bit UINT	Fine Debris %	0 -100 (0 d.p.)
40002	16-bit UINT	Coarse Debris %	0 -100 (0 d.p.)
40003	16-bit UINT	Oil Status	800 -1200 (0 d.p.)
40004 to 40005	32-bit Float	Oil Probe Temperature °C	-26 – +150°C (2 d.p.)
40006 to 40009	-	Manufacturer Specific	-
40010	16-bit UINT	Status Codes	-
40011 to 40018	16 Char String	Sensor Name	[A-Z], [a-z], [0-9], dashes, dot and brackets.
40019 to 40026	16 Char String	Sensor Location	-
40027 to 40050	-	Manufacturer Specific	-

Supported Functions

The sensor supports the following functions:

- FC03 (0x03) Read Holding Registers
- FC06 (0x06) Write Holding Registers
- FC16 (0x10) Write Multiple Holding Registers
- FC17 (0x11) Report Slave ID

Note; FC06 and FC16 can be used to adjust the data in "Sensor Name" and "Sensor Location" registers.

Status (error) codes

To aid troubleshooting, the following status codes are shown in the Gill Configurator start up window:

Communications (error) codes

Code	Status	Description
OK	Normal Operation	Normal Operation
01	Temperature alarm	Temperature over/below threshold
02	Water Contamination high	Water Contamination above threshold
04	Water Contamination low	Water Contamination below threshold
08	Fine error	Fine channel error
10	Coarse error	Coarse channel error
20	Water Contamination error	Water Contamination channel error
40	Internal temperature error	Processing electronics temperature out of range
80	External temperature error	Sensor head temperature out of range

If a communication error occurs a communications fail error message will be displayed in the Gill Configurator start-up window. Please check power and communication connections and restart the Gill Configurator.

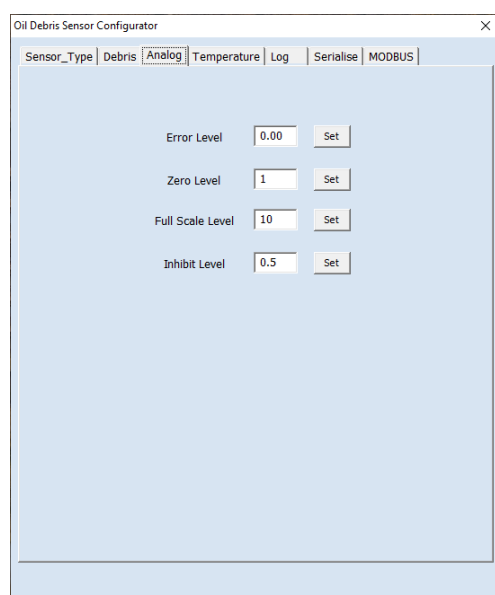

Maximum Range Coarse Debris

The following maximum range numbers are provided as a guideline only and these numbers should be confirmed with actual coarse debris samples.

Coarse Debris Size	Material Type	Maximum No. Off
2mm	Chrome Steel Ball Bearing	>20
3mm	Chrome Steel Ball Bearing	20
5mm	Chrome Steel Ball Bearing	10

Note: Results may vary with more debris layers, different materials and positional variation.

Maximum Range Fine Debris

The following maximum range numbers are provided as a guideline only and these numbers should be confirmed with actual fine debris samples.

Note: Results may vary with more debris layers, different materials and positional variation.

Fine Debris Size	Material Type	Maximum mass (g)
1-6 µm	Iron Powder	0.41g
60 µm	Iron Powder	0.44g
125-300 µm	Iron Powder	0.43g
450 µm	Iron Fillings	0.48g
420-850 µm	Iron Fillings	0.35g

Interaction between Coarse and Fine Channels

The coarse channel is not affected by the presence of fine debris particles.

The fine channel can be affected by the presence of a large amount of coarse debris, in excess of 2 x 2mm chrome steel ball bearings. In normal use the coarse channel operates independently of the fine channel.

It is recommended that during the set-up procedure the coarse channel is set to alarm when 1 x 2mm chrome steel ball bearing is on the sensor head to give the earliest warning of a significant failure.

Parameter	Sensitivity Scale	
	Small	
Third Channel	Water contamination (alarm)	
Inhibit Output During Configuration	Switched off	
Disable Fine Channel		
Disable Coarse Channel		
Disable Oil Status / Temperature Channel	Switched Off	
100% FSD Course	1 x 3mm Chrome steel ball bearing	
100% FSD Fine	0.1g iron powder	
Water Contamination	Reference Oil Type	Mineral Oil
	No Oil Threshold	1010
	Water Contamination Threshold	985
	Filter Time	1 Second
Temperature Status	High Temperature Alarm	+150 °C
	Low Temperature Alarm	-26 °C
LED Brightness (Sensor with display models only)	Maximum	
0-10V Outputs	Error Level	0.0V
	0% FSD	2V
	100% FSD	10V
	Inhibit	0.5 v
4-20 mA Outputs	Error Level	0 mA
	0% FSD	4 mA
	100% FSD	20 mA
	Inhibit	2 mA

Sensors with Display (Industrial)			
Electrical Enclosure	Current (mA)	Voltage (V)	CAN (J1939)
Supply voltage Over-voltage protection Power consumption Reverse polarity protection Resolution Report update rate Configuration interface	+9 V to +26 V DC > 32 V DC < 5.6 Watts > -32 V 10-bit 10 Hz Micro USB	+6 V to +26 V DC > 32 V DC < 2.9 Watts > -32 V 10-bit 10 Hz Micro USB	+5 V to +32 V DC ¹ > 32 V DC < 0.7 Watts > -32 V 7-bit 1 Hz Micro USB
Connections and outputs			
CLEAR WHITE BLUE RED BLACK GREEN ORANGE	NC Fine, 4 to 20 mA NC Supply Voltage Ground (0 V DC) Coarse, 4 to 20 mA Oil/Temp, 4 to 20 mA	NC Fine, 0 to 10 V NC Supply Voltage Ground (0 V DC) Coarse, 0 to 10 V Oil/Temp, 0 to 10 V	NC CAN H ² CAN L ² Supply Voltage Ground (0 V DC) NC NC
Error indication	All outputs , 0 – 20 mA	All outputs , 0 – 10 V	-
Output inhibit ³	All outputs , 0 – 20 mA	All outputs , 0 – 10 V	-
Multicolour light ring ⁴	All outputs		
Wire range	35 to 13 AWG (solid) OR 35 to 15 AWG (stranded)		

¹ — The supply voltage must be 0.7 V greater than the configured output voltage; for a 5 V output the supply must be greater than 5.7 V.

² — CAN output does not have an internal Termination Resistor.

³ — The Output Inhibit is the Analogue output when configuring the sensor.

⁴ — For the function of the multicolour light ring see image below.

⁵ — Bootlace ferrules are provided to protect the wires from damage by the screw terminals.

CAN Connection Specifications		Message Format		
Standard Approval Data Length PGN Report rate Can bit rate	J1939 Compatible 8 bytes 130816 1 Hz 250 kb/s	Byte 0 Byte 1 Byte 2 Byte 3 Byte 4 Byte 5 Byte 6 Byte 7	Coarse measurement 0 to 100%, (1%/bit) Fine measurement 0 to 100%, (1%/bit) 8 x Status bits (Mux) Multiplex of next 5 bytes ² Meaning depends on value of Byte 3 ²	
Byte 3	0x00 to 0x07	0x08	0x09	0x0A to 0x13
Byte 4-7	Manufacture Specific	Oil Dielectric (1024) ³	Oil Probe Temperature (0.0625°C/ bit)	Manufacture Specific

¹ — For decoded Status Bits, see Table XXX in Appendix B.

² — See rows Bytes 3 and Bytes 4-7.

³ — Oil Dielectric measurement value centred around 1024.

WearDetect

Oil Debris Sensor

Mechanical	Sensor	Enclosure
Size	57 mm x ø24.5mm	105.5 mm (w) x 105.5 mm (l) x 66 mm (h)
Mounting	Threaded	2 off M6 socket-cap screws (not supplied)
Materials	Stainless steel, FEP, PEI	Al. alloy, Stainless steel, polyester
Weight	0.7 kg in total	

Sensors (Inline)				
Electrical Enclosure	Current (mA)	Voltage (V)	CAN (J1939)	Modbus RTU
Supply voltage	+9V to +32V DC	+6V to +32V DC 1	+5V to +32V DC	+5V to +32V DC
Over-voltage protection	> 32 V DC	> 32 V DC	> 32 V DC	> 32 V DC
Power consumption	< 2.6 Watts	< 0.7 Watts	< 0.7 Watts	< 0.7 Watts
Reverse polarity protection	> -32 V	> -32 V	> -32 V	> -32 V
Resolution	10-bit	10-bit	See Message Format	See Message Format
Report update rate	10 Hz	10 Hz	1 Hz	1 Hz
Configuration interface	Micro USB	Micro USB	Micro USB	Micro USB
Connections and outputs				
CLEAR	NC	NC	NC	NC
WHITE	Fine, 4 to 20 mA	Fine, 0 to 10 V	CAN H 2	Signal Ground
BLUE	NC	NC	CAN L 2	NC
RED	Supply Voltage	Supply Voltage	Supply Voltage	Supply Voltage
BLACK	Ground (0V DC)	Ground (0V DC)	Ground (0V DC)	Ground (0V DC)
GREEN	Coarse, 4 to 20 mA	Coarse, 0 to 10 V	NC	DATA + (A)
ORANGE	Oil/Temp, 4 to 20 mA	Oil/Temp, 0 to 10 V	NC	DATA - (B)
Error indication	All outputs , 0 – 20 mA	All outputs , 0 – 10 V	-	-
Output inhibit 3	All outputs , 0 – 20 mA	All outputs , 0 – 10 V	-	-
Flying Leads	7 x 26 AWG / 0.15mm STRANDED , OD: 4.0 ± 0.2mm			

¹ — The supply voltage must be 0.7V greater than the configured output voltage; for a 5V output the supply must be greater than 5.7V.

² — CAN output does not have an internal Termination Resistor.

³ — The Output inhibit is the Analogue output when configuring the sensor.

NC—Do not connect at flying lead end

CAN Connection Specifications		Message Format		
Standard Approval Data Length PGN Report rate Can bit rate	J1939 Compatible 8 bytes 130816 1 Hz 250 kb/s	Byte 0 Byte 1 Byte 2 Byte 3 Byte 4 Byte 5 Byte 6 Byte 7	Coarse measurement 0 to 100%, (1%/bit) Fine measurement 0 to 100%, (1%/bit) 8 x Status bits (Mux) Multiplex of next 5 bytes ² Meaning depends on value of Byte 3 ²	
Byte 3	0x00 to 0x07	0x08	0x09	0x0A to 0x13
Byte 4-7	Manufacture Specific	Oil Dielectric (1024) ³	Oil Probe Temperature (0.0625°C/bit)	Manufacture Specific
Modbus Connection Specifications		Message Format (Register, Data Type, Description)		
Standard Baud Rate Data / Parity / Stop Bit(s) Slave ID Byte/Word Order Error Check Frame Start / End Gaps in Message Supported Function Codes	RS-485 Half-Duplex 4.8 to 57.6 kb/s 8E1, 8O1, 8N2 1 to 247 High Byte/Word First Cyclic Redundancy Check (CRC) 3.5 Characters Silence 1.5 Characters Length 0x03, 0x06, 0x10, 0x11	40001 40002 40003 40004 to 40005 40006 to 40009 40010 40011 to 40018 40019 to 40026 40027 to 40050	16-bit UINT 16-bit UINT 16-bit UINT 32-bit Float - 16-bit UINT 16 Char String 16 Char String -	Fine Debris % Coarse Debris % Oil Status ⁴ Oil Probe Temperature °C Manufacturer Specific Status Codes Sensor Name Sensor Location Manufacturer Specific

1 — For decoded Status Bits, see Table XXX in Appendix B.

2 — See rows Bytes 3 and Bytes 4-7.

3 — Oil Dielectric measurement value centred around 1024.

4 — See Status (error) Codes Section to decode values.

Mechanical	Sensor	Enclosure
Size	57 mm x ø24.5mm	55 mm (w) x 30 mm (l) x 12 mm (h)
Mounting	Threaded	2 off M4 screws (not supplied)
Materials	Stainless steel, FEP, PEI	Al. alloy, Stainless steel, polyester
Weight	0.21 kg in total	

Appendix B

Analog Output

For analogue output sensors, the following values can be set by the user:

Error Level

The sensor output level at an error state may be set by the user to identify a sensor failure. Input the desired error level value into the dialogue box and press the set button to write the value to the sensor.

Note: the error level is applied to all three output channels

Analog Output

For analogue output sensors, the following values can be set by the user:

Error Level

The sensor output level at an error state may be set by the user to identify a sensor failure. Input the desired error level value into the dialogue box and press the set button to write the value to the sensor.

Note: the error level is applied to all three output channels

Zero level

The sensor output level may be set by the user to identify 0% FSD. Input the desired zero level (0%) value into the dialogue box and press the set button to write the value to the sensor.

Note: The error level is applied to all three output channels

Note: For continuous water/temperature, this value represents the output at the Water Contamination / Low Temperature Threshold Alarm

Full Scale Level

The sensor output level may be set by the user to identify 100% FSD. Input the desired full scale (100%) level value into the dialogue box and press the set button to write the value to the sensor.

Note: The error level is applied to all three output channels

Note: For continuous water/temperature, this value represents the output at the No Oil / High Temperature Threshold Alarm

Inhibit Level

The sensor "inhibit level" may be set by the user to set the sensor output during maintenance and cleaning operations to a known state. Input the desired inhibit level value into the dialogue box and press the set button to write the value to the sensor.

CAN

Note: For alternative CAN configurations consult Gill with your custom requirements

For CAN output sensors, the following values are displayed:

Function Instance

“Function instance” works in combination with the function field. A J1939 network may accommodate several ECUs (Controller Applications) with the same function. The 5 bit long function instance assigns a number to each instance of the function, where 0 is assigned to the first instance.

The function instance is factory set to 0000. Input the desired value into the dialogue box and press the set button to write the value to the sensor.

ECU Instance

A J1939 network may accommodate several ECUs (controller applications) with the same function. The 3 bit long ECU instance assigns a number to each instance of the ECU, where 0 is assigned to the first instance.

“ECU instance” is factory set to 0000. Input the desired value into the dialogue box and press the set button to write the value to the sensor.

Industry Group

Industry group codes are associated with particular industries. The 3 bit code is assigned by the SAE and definition can be found in the J1939 standard.

“Industry group” is factory set to 0000.

Vehicle System Instance

A J1939 network may accommodate several ECUs of the same vehicle system. The 4 bit long vehicle system instance assigns a number to each instance of the vehicle system (0 to 15).

“Vehicle system instance” is factory set to 0000.

Vehicle System

This 7 bit field is defined and assigned by the SAE. Definitions of the vehicle system are found in the J1939 standard.

“Vehicle system” instance is factory set to 0000.

Function

The function field is defined and assigned by the SAE. The range of the field is from 0 to 255. The function code does not depend on any other field in cases where it is less than 128 (0 to 127).

WearDetect

Oil Debris Sensor

Manufacturer Code

The 11 bit Manufacturer code is assigned by the SAE and it indicates which manufacturer produced this particular equipment.

"Manufacturer code" is factory set to 07ff.

Identity Number

The identity number is assigned by the manufacturer and should be used to guarantee unique names within

"Identity number" is factory set to 0000.

NAME

The 64 bit name is used to uniquely identify each equipment in a network. The *"NAME"* field contains 10 entries of which five are assigned by the SAE. The remaining five fields are derived from the network characteristics or are manufacturer specific.

The *"NAME"* field is also used during the claim process when two or more equipment's are attempting to claim the same address. In such a case the equipment with a name of higher priority (=lower numeric value) will claim the address.

PGN/ID

For CAN output sensors, the following values are displayed:

Priority

There are 8 priority levels which represent the equipment priority during the arbitration process. In compliance with the CAN standard a value of 0 has the highest priority and a value of 8 has the lowest priority.

"Priority number" is factory set to 0006.

Data Page

Data page bit works as a page selector for the protocol data unit.

"Data page" is factory set to 0001.

PDU Format

The protocol data unit defines the function of the PDU specific. A value of 240 to 255 is a destination address broadcast message. A value between 0 – 239 is a group extension peer-to-peer message.

The PDU format is factory set to 00ff.

PDU Specific

PDU specific means that its content is interpreted according to the information in the PDU format. A value 240 to 255 is a destination address broadcast message. A value between 0 – 239 is a group extension peer-to-peer message.

“PDU specific” is factory set to 0000.

The last 8 bits of the message identifier contains the address of the transmitting equipment. There is a total of 253 addresses available and every address must be unique within the network.

Input the desired value into the dialogue box and press the set button to write the value to the sensor.

PGN

The parameter group number (PGN) uniquely identifies the parameter group that is being transmitted in the message. The structure of the PGN permits a total of up to 8672 different parameter groups to be defined.

The PGN is compiled from the assignment of each parameter.

CAN ID

The CAN ID is displayed in this window.

Miscellaneous settings

LED Brightness (Sensors with display Only)

To make adjustments to the LED brightness:

Select the Sensor>Brightness option from the top pull down menu and select the desired LED brightness.

Exporting a Configuration File

When your WearDetect Oil Debris Sensor is fully configured it is recommended that the configuration is saved for future reference. The configuration file contains all of the user configurable information. Follow the steps below to import and export a configuration file.

Select the Sensor>Export option from the top pull down menu.

Enter the file name and save the file (*.dsc) to a suitable location on your PC.

Importing a Configuration File

To set up your sensor with a pre-saved configuration file use the following steps to import the pre-configured settings:

Select the Sensor>Import option from the top pull down menu.

Navigate and select the required configuration file (*.dsc) and press the open button. The new configuration file will be automatically loaded.

Restore Factory Defaults

The following factory defaults are loaded into the sensor and can be restored at any time during sensor configuration. The sensor is shipped with the measurement scale set to small. The default configuration settings are defined below:

Appendix C

Grounding Schemes and Recommendations

The Oil Debris Sensor complies with International EMC standards. In order to maintain compliance with these standards it is essential that the electrical installation is engineered correctly. Electrical installation standards and practices vary for different countries and installation companies. It is the responsibility of the electrical installation design authority to determine the applicable standards / practices and ensure compliance with them. When designing electrical installations for the Oil Debris Sensor it is recommended that the design authority considers the following:

- For the Sensor with display models, a safety earth connection can be made by a wire connected to the unit's external earthing point.

When deciding how to earth the unit, consideration should be given to the recommendations below.

- Ideally, the cases of both the units and the sensor should not be connected to electrically noisy (dirty) metalwork or conductors. Preferably, they should both be connected to a low noise instrument (clean) earth.
- For the display electronics enclosure, the field cable's screen should be connected to the sensor screen via the terminations provided within the enclosure, providing a single, continuous earth screen connected to a low noise instrument (clean) earth. This connection must not be allowed to complete an earth loop or connect instrument earth to safety earth.
- If armoured cable is being used it is necessary to prevent safety (dirty) earth from becoming connected to instrument (clean) earth via the earth connections inside the enclosure. This is most easily achieved by the use of insulating cable glands for the field cable entry.
- If it is not practical to isolate the unit's case from safety (dirty) earth the enclosure should be earthed in a manner that complies with local regulations.
- Equipment that the sensor head is installed into should be grounded to allow greater dielectric measurement accuracy.

Appendix D

Environmental

	Sensor Head	Inline Electronics & Cable	Display Electronics & Cable
Operational Temperature	-26°C to +150°C EN60068-2-1, ISO16750-4	-40°C to +85°C EN60068-2-1, ISO16750-4	-40°C to +85°C EN60068-2-1, ISO16750-4
Protection	IP68 / IP69k to EN60529	IP66/IP68 to EN60529	IP65 to EN60529
Humidity	95% RH +55 °C EN60945, EN60068-2-30 Test Db, ISO16750-4		
Thermal Shock	EN60945 EN60068-2-14 Test Na, ISO16750-4		
EMC	EN60945 (Marine) EN61000-6-3, EN61000-6-1 (Light industrial) EN61000-6-4, EN61000-6-2 (Heavy industrial) EN61326-2-1 (Measurement and control) EN13309 (Construction machinery) ISO 13766 (Earth moving machinery) ISO 14982 (Agricultural & Forest machinery) FCC ClassA Digital Device, part 15 *		
Vibration	EN60945 (Marine**) 3 axis, 2 to 13Hz, +/-1mm EN60068-2-6 (Industrial) 3 Axis, 10 to 55 Hz 0.75mm or 10g and 13.2Hz to 100Hz constant acceleration of 0.7g EN60068-2-27(Shock) 3 Axis, 25g, 6ms, 1000 cycles		
Chemical compatibility	Fuels, Oils, Coolants, Fluids, Diesel, Gasoline, Hydraulic, Gear, Motor, Vegetable, Synthetic ester, Polyalphaolefin, Polyglycol, Ethylene Glycol, water, Salt water		
Differential pressure	10 bar		
Cable pull	50 N all 3 axis		
General handling	1 m drop all 3 sides (in packaging)		

Returning a Faulty Sensor

Should a fault arise during the use of your Oil Debris Sensor which is within the warranty period, or if you require a repair to your sensor please contact Gill Sensors & Controls for a Return Material Authorization number (RMA). Please ensure any return units are cleaned prior to shipment.

Appendix E

Product variants

Part No.	Variant
4212-PK-145	Sensor with display models 4-20mA output
4212-PK-146	Sensor with display models 0-10V output
4212-PK-147	Sensor with display models CAN output
4212-PK-148	Sensor without display models 4-20mA output
4212-PK-149	Sensor without display models 0-10V output
4212-PK-150	Sensor without display models CAN output
4212-PK-151	Sensor without display models Modbus output

All product variants require a thread adaptor to allow installation with the chosen equipment. Please contact Gill for a list of the available adaptors at the time of writing. Gill recommend getting in contact as these are constantly being updated according to demand.

Optional

Part No.	Variant
4212-00-160-150	Inflow Adaptor Kit 1.5" (Also fits 1.25")
4212-00-160-100	Inflow Adaptor Kit 1" (Also fits 0.75" & 0.5")
4212-00-161	Inflow Adaptor
4212-10-051-X	Conduit kit (display model only)

Important Notices:

- Gill Sensors & Controls Limited can take no responsibility for installation and/or use of its equipment if this is not done in accordance with the appropriate issue and/or amendment of the manual.
- The user of this manual should ensure that it is appropriate in all details to the exact equipment to be installed and/or operated. If in doubt, the user should contact Gill Sensors & Controls Limited for advice.
- If further details are required which do not appear in this manual, contact Gill Sensors & Controls Limited or one of their agents.
- Install and use the Oil Debris Sensor in accordance with the local regulations.
- Gill Sensors & Controls Limited reserve the right to change or revise the information supplied in this document without notice and without obligation to notify any person or organisation of such revision or change.

Help Us to Help You:

Every effort has been made to ensure the accuracy in the contents of our documents, however, Gill Sensors & Controls Limited can assume no responsibility for any errors or omissions in our documents or their consequences. Gill Sensors & Controls Limited would greatly appreciate being informed of any errors or omissions that may be found in the contents of any of our documents.

After Sales Support

Should you require after sales assistance with this product, please go to www.gillsc.com where you can request support by clicking on the "Get Support" button and filling out the form. Alternatively, call us during UK office hours on 01590 613900 (UK). Please have details of the product and serial number whenever possible.

Additionally, you can access further information on the product from the support section of the website at www.gillsc.com/support

Gill Sensors & Controls Limited
Unit 600, Ampress Park, Lymington,
Hampshire, SO41 8LW, UK
Tel: +44 1590 613900
Website: www.gillsc.com